



## COMPLETE CATALOG

*Carriage House*  
*Fine Kitchen Cabinetry*





# Contents

PROCEDURES.....	P.1
FORMS .....	M.1
FINISHES .....	F.1
DOORS .....	D.1
UPPER CABINETS .....	1.1
BASE CABINETS .....	2.1
VANITY CABINETS.....	3.1
DESK CABINETS .....	4.1
TALL CABINETS .....	5.1
FACE FRAMES.....	6.1
DRAWERS .....	7.1
FILLERS .....	8.1
PANELS.....	9.1
MOLDINGS .....	10.1
TOE KICKS .....	11.1
LEGS.....	12.1
APPLIANCE PANELS.....	13.1
HOODS .....	14.1
MANTELS .....	15.1
PARTS .....	16.1
ACCESSORIES.....	17.1
INDEX .....	A1.1



*Carriage House*  
*Fine Kitchen Cabinetry*

# PROCEDURES



*Carriage House*  
*Fine Kitchen Cabinetry*



**PROCEDURES**

*Carriage House, Fine Kitchen Cabinetry*

	CODE	PRICE
<p>CUT DOWNS When cabinets are cut down on job site: add 200 or price of cabinet add for doors</p>		200

**CODE**

**PRICE**



# FORMS



*Carriage House*  
*Fine Kitchen Cabinetry*



**CODE**

**PRICE**

**CODE**

**PRICE**



# FINISHES



*Carriage House*  
*Fine Kitchen Cabinetry*



**FINISHES***Carriage House, Fine Kitchen Cabinetry*

	<b>CODE</b>	<b>PRICE</b>
<b>PAINT GRADE DISTRESSING PACKAGES</b>		
MOUNTAIN		%
OLD WORLD		%
CLASSIC		%
BURN THROUGH EDGES		%
<b>STAIN DISTRESSING PACKAGES</b>		
MOUNTAIN		%
OLD WORLD		%
CLASSIC		%
BURN THROUGH EDGES		%
NATURAL		0%
<b>GLAZING</b>		
CLASSIC		%
WARM		%
WILD		%
SPECIAL		0%
<b>TOP COAT</b>		
10 SHEEN		%
20 SHEEN		%
40 SHEEN		%

**CODE**

**PRICE**



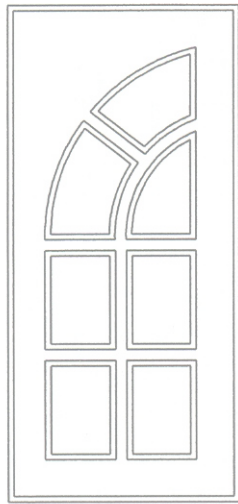

# DOORS

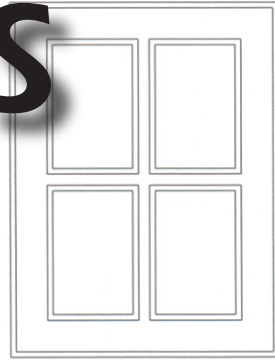

*Carriage House*  
*Fine Kitchen Cabinetry*



**DOORS**

*Carriage House, Fine Kitchen Cabinetry*

**D.1**

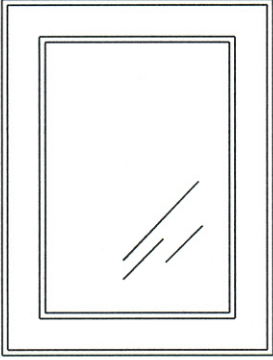
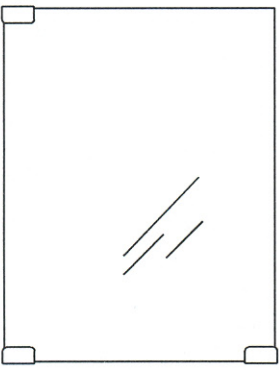
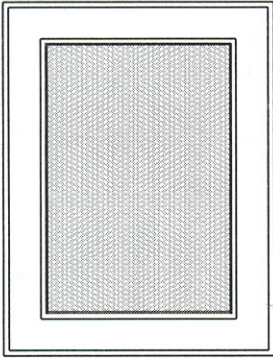
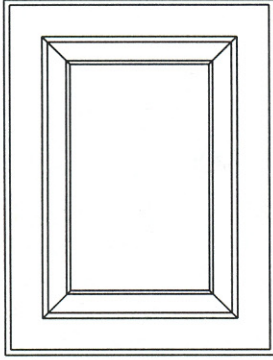
		CODE	PRICE
	<p><b>GLASS DOOR</b>                      •1/8" Clear Glass Only                      or prep for glass</p>	Clear Glass Insert CGI	15 PER SQ. FT.
	<p>Add for Door</p> <p>Tempered Glass CGIT</p> <p>For other glass types or custom styles</p>		30 PER SQ. FT.
	<p><b>1/4" GLASS DOOR</b>                      •Polished 4 sides                      •Doors cannot be inset</p>	Glass Door GD	75 PER SQ. FT.
	<p>Glass Door Tempered GDT</p>		90 PER SQ. FT.
	<p><b>SPEAKER CLOTH</b>                      •See sample page for colors</p> <p>Add for Door</p>	SC	25 PER SQ. FT.
	<p><b>SAMPLE DOOR</b>                      •13" Wide x 17-1/2" High</p>	SAMPLE	75

**DOORS***Carriage House, Fine Kitchen Cabinetry***D.2**

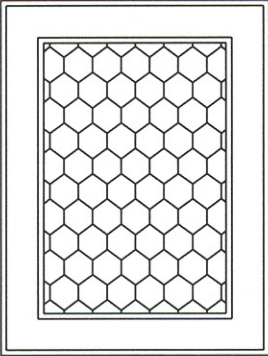
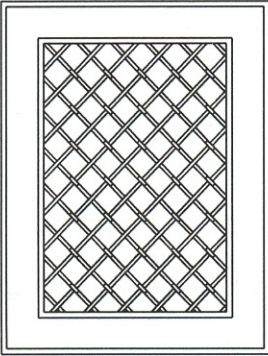
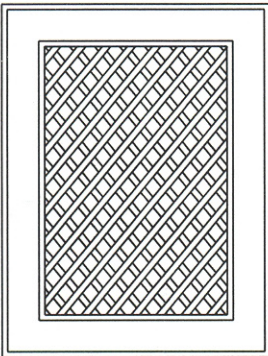
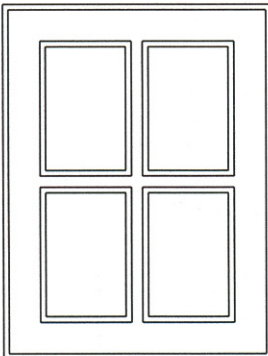
		<b>CODE</b>	<b>PRICE</b>
	<p>CHICKEN WIRE •1/2" hex wire Antique Brass</p> <p>Add for Door</p>	CW	50 PER SQ. FT.
	<p>GRILL WIRE •3/4" small wire grill Antique Brass</p> <p>Add for Door</p>	WG	80 PER SQ. FT.
	<p>WOOD MESH •1/4" x 1/4" squares</p> <p>Add for Door</p>	WM	150 PER SQ. FT. 300 MINIMUM
	<p>MULLION DOOR</p> <p>Add for Door</p>	MU01	160

**DOORS***Carriage House, Fine Kitchen Cabinetry***D.3**

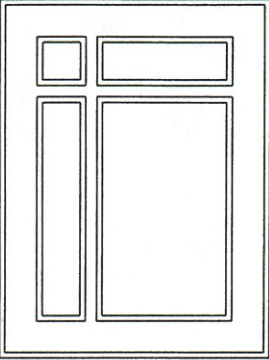
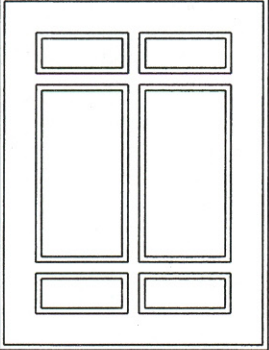
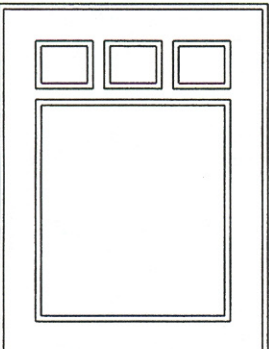
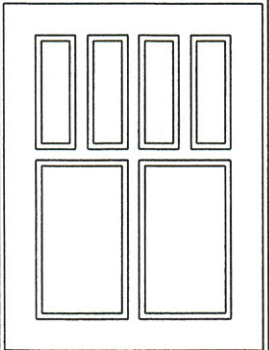
		<b>CODE</b>	<b>PRICE</b>
	MULLION DOOR  Add for Door	MU02	160
	MULLION DOOR  Add for Door	MU03	160
	MULLION DOOR  Add for Door	MU04	160
	MULLION DOOR  Add for Door	MU05	160

**DOORS***Carriage House, Fine Kitchen Cabinetry***D.4**

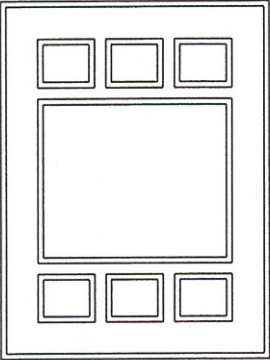
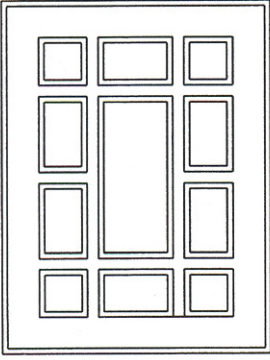
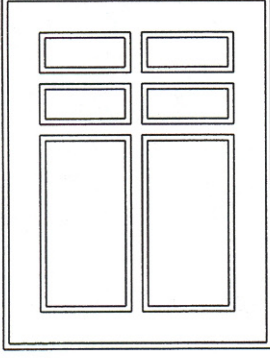
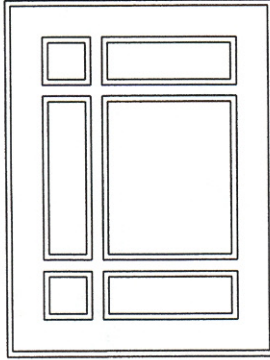
		<b>CODE</b>	<b>PRICE</b>
	MULLION DOOR  Add for Door	MU06	160
	MULLION DOOR  Add for Door	MU07	160
	MULLION DOOR  Add for Door	MU08	160
	MULLION DOOR  Add for Door	MU10	160

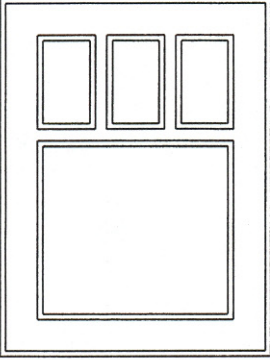
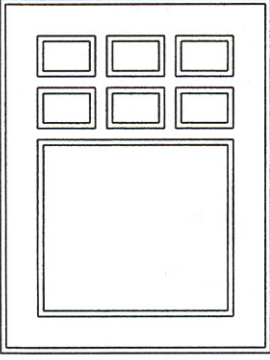
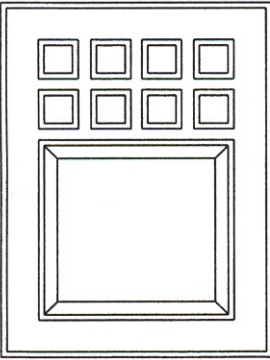
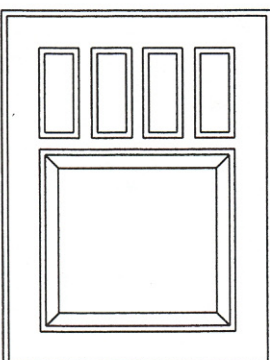

**DOORS***Carriage House, Fine Kitchen Cabinetry***D.5**

		<b>CODE</b>	<b>PRICE</b>
	MULLION DOOR  Add for Door	MU15	160
	MULLION DOOR  Add for Door	MU20	160
	MULLION DOOR  Add for Door	MU22	200
	MULLION DOOR  Add for Door	MU23	200

		<b>CODE</b>	<b>PRICE</b>
	<p><b>MULLION DOOR</b></p> <p>Add for Door</p>	<p>MU25</p>	<p>160</p>
	<p><b>ARCHED MULLION DOOR</b></p> <p>Add for Doors</p>	<p>MU30</p>	<p>490 PER DOOR</p>
	<p><b>ARCHED MULLION DOOR</b></p> <p>Add for Doors</p>	<p>MU31</p>	<p>590 PER DOOR</p>

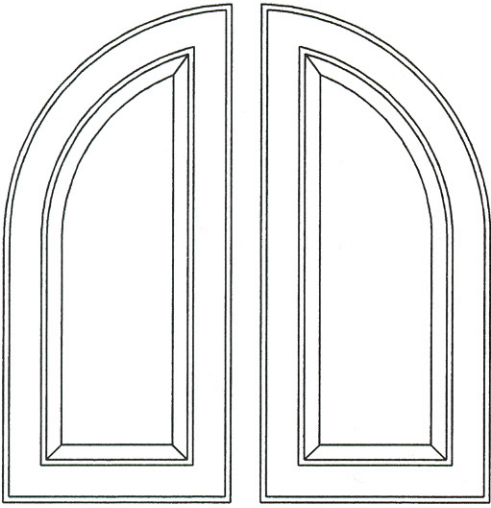
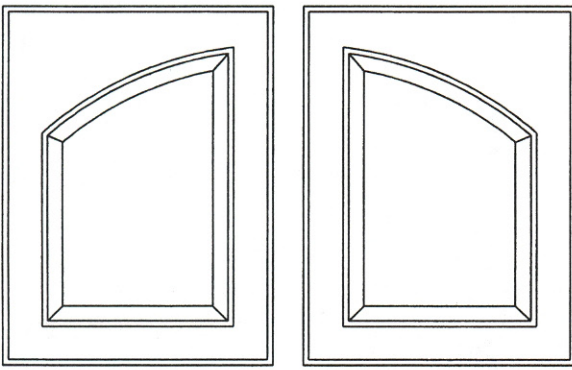
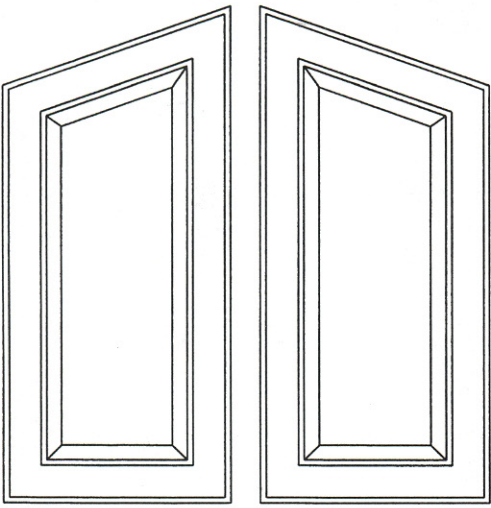

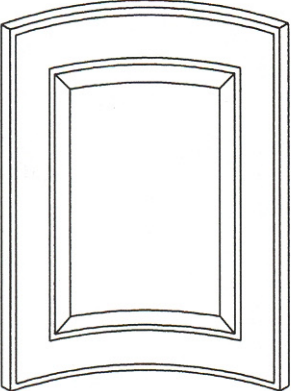
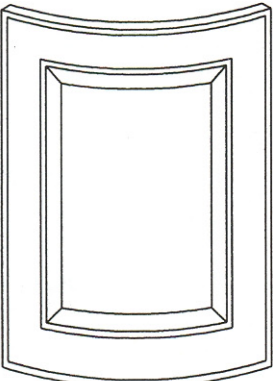
		CODE	PRICE
	<p>ARCHED DOORS</p> <p>Add for Doors</p>	AD31	290 PER DOOR
	<p>ARCHED PANEL DOORS</p> <p>Add for Doors</p>	AD32	180 PER DOOR
	<p>ANGLED TOP DOORS</p> <p>Add for Doors</p>	AD33	290 PER DOOR

		CODE	PRICE
 <p>CONCAVE</p>	<p><b>CURVED DOOR</b></p> <ul style="list-style-type: none"> <li>•Concave</li> <li>•Includes Cabinet Radius</li> </ul>	"A" Doors CONCAVEA	200 PER SQ. FT.
	<p>Add for Cabinet</p>	"B" Doors CONCAVEB	300 PER SQ. FT.
		"C" Doors CONCAVEC	400 PER SQ. FT.
	<p>Radius doors come in 24" radius, 28" radius, 32" radius, and 36" radius</p> <p>Add for jig for custom sizes</p>	JIGS	400
 <p>CONVEX</p>	<p><b>CURVED DOOR</b></p> <ul style="list-style-type: none"> <li>•Convex</li> <li>•Includes Cabinet Radius</li> </ul>	"A" Doors CONVEXA	200 PER SQ. FT.
	<p>Add for Cabinet</p>	"B" Doors CONVEXB	300 PER SQ. FT.
		"C" Doors CONVEXC	400 PER SQ. FT.
	<p>Radius doors come in 24" radius, 28" radius, 32" radius, and 36" radius</p> <p>Add for jig for custom sizes</p>	JIGS	400
 <p>FLAT</p>  <p>PANELED</p>	<p><b>CURVED DRAWER FRONT</b></p> <ul style="list-style-type: none"> <li>•Concave or Convex</li> <li>•Includes Cabinet Radius</li> </ul>	Flat CURVEDDRF	220 PER SQ. FT.
	<p>Add for Cabinet</p>	Paneled CURVEDRP	250 PER SQ. FT.
	<p>Radius doors come in 24" radius, 28" radius, 32" radius, and 36" radius</p> <p>Add for jig for custom sizes</p>	JIGS	400

		CODE	PRICE
	<p><b>TALL DOORS</b></p> <ul style="list-style-type: none"> <li>•Doors over 48" high</li> <li>•Rail can be any configuration</li> </ul> <p>Doors without center rail add 2.5%</p>	<p>NORAIL</p>	<p>2.5%</p>
	<p><b>DOOR CATCH</b></p> <p>Tall doors may need a catch because of warpage. It is a standard and acceptable practice to do so.</p> <p><i>Please tell your client of this possibility.</i></p>	<p>CATCH</p>	<p>25</p>
	<p><b>PAINTED PANELS</b></p> <ul style="list-style-type: none"> <li>•Panels finished prior to installation in frame</li> </ul> <p>Doors</p> <p>Drawer Fronts</p>	<p>PAINTPAN</p>	<p>40</p>
		<p>PAINTDRW</p>	<p>30</p>

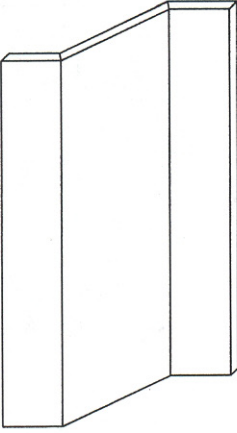
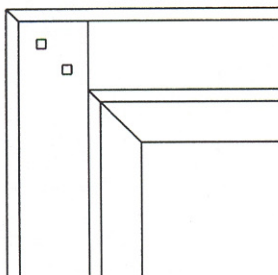
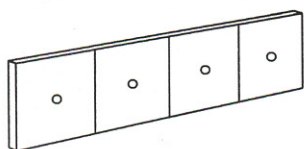
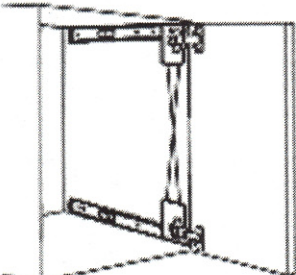
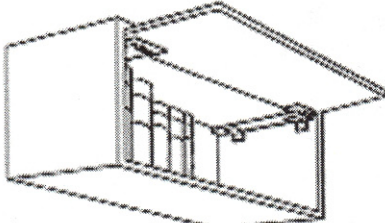
		CODE	PRICE				
 <p>"Z" Door</p> <p>Add for Door</p> <p>Smaller doors need to be made solid</p> <p>Raised Panel Doors have limitations</p>		ZDOOR	200				
 <p>SQUARE PEGS</p>		PEG	5 EACH				
 <p>MULTIPLE FRONTS</p> <p>When using more than one front on a drawer or door the fronts need to be splined together to appear as one</p>		MF	44 EACH FRONT ADD FOR RAISED PANEL FRONTS				
 <p>VERTICLE FLIPPER® DOOR SLIDES</p> <ul style="list-style-type: none"> <li>•Slide Cable System</li> <li>•75 lb. Capacity</li> </ul> <p>Factory recommended hinges per door:</p> <table> <tr> <td>Over 36" - 3 hinges</td> <td>Over 48" - 4 hinges</td> </tr> <tr> <td>Over 60" - 5 hinges</td> <td>Over 72" - 6 hinges</td> </tr> </table>	Over 36" - 3 hinges	Over 48" - 4 hinges	Over 60" - 5 hinges	Over 72" - 6 hinges		PD	350 PER DOOR
Over 36" - 3 hinges	Over 48" - 4 hinges						
Over 60" - 5 hinges	Over 72" - 6 hinges						
 <p>OVER THE TOP FLIPPER® DOOR SLIDES</p> <ul style="list-style-type: none"> <li>•20 lb. Capacity</li> </ul> <p>Maximum Door Width 36"</p>		PD	350 PER DOOR				





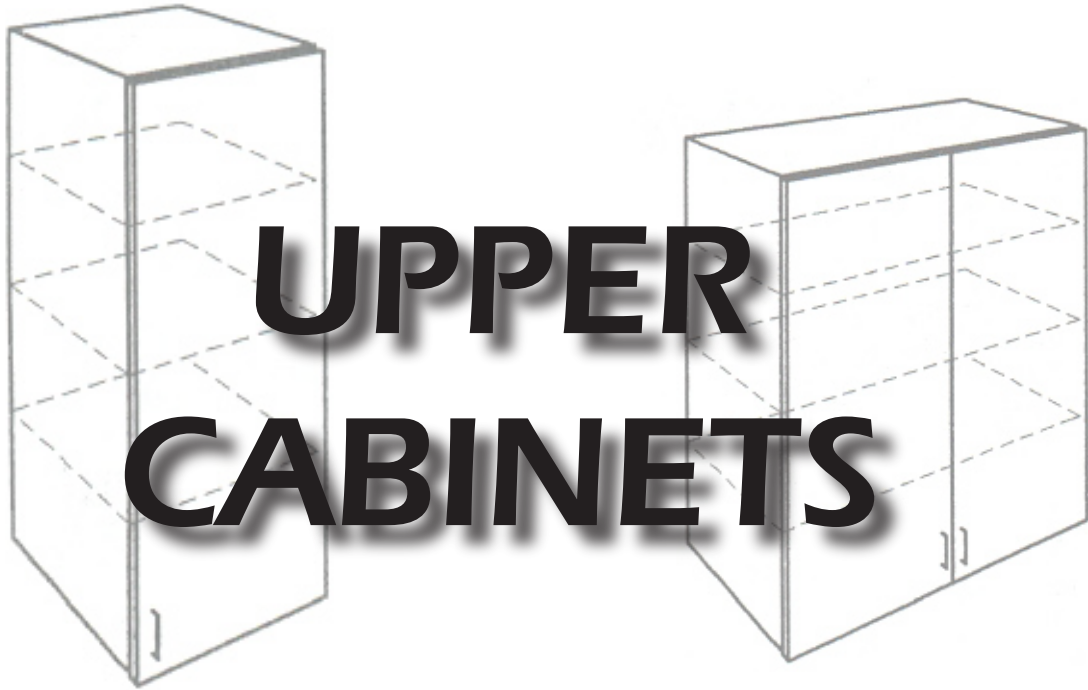

*Carriage House*  
*Fine Kitchen Cabinetry*







**UPPER CABINETS**

*Carriage House, Fine Kitchen Cabinetry*

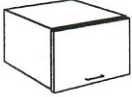
**1.1**

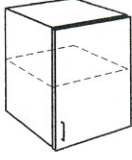
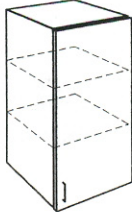
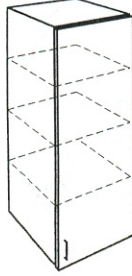
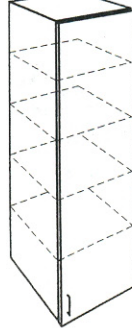
		SHELVES	CODE	W	H	D	PRICE	
	SINGLE LIFT UP DOOR	0	W0912	9	12	12	125	
			W1512	15	12	12	150	
			W2412	24	12	12	175	
    	SINGLE DOOR Specify left or right hinge	0	W0912	9	12	12	125	
			W1512	15	12	12	150	
			W2412	24	12	12	175	
			W0915	9	15	12	125	
			W1515	15	15	12	165	
			W2415	24	15	12	190	
			W0918	9	18	12	150	
			W1518	15	18	12	190	
			W2418	24	18	12	210	
			1	W0924	9	24	12	200
			W1524	15	24	12	225	
			W2424	24	24	12	245	
			W0930	9	30	12	225	
			W1530	15	30	12	250	
			W2430	24	30	12	270	
			2	W0936	9	36	12	275
			W1536	15	36	12	305	
			W2436	24	36	12	330	
3	W0942	9	42	12	315			
W1542	15	42	12	340				
W2442	24	42	12	370				
4	W0960	9	60	12	472			
W1560	15	60	12	510				
W2460	24	60	12	555				

Additional Depths    12" to 15" add 10%  
                           15" to 18" add 15%  
                           18" to 21" add 20%

Interior Options Black and Almond Melamine - add 10% of case  
                           Stock Melamine Colors - add 25% of case  
                           Finished Wood and other Melamine Colors - Double price of case



Additional Melamine Shelves - MS - \$25 each

Fractions            Add \$125 per cabinet  
 Custom Items    Add 30% to cabinet price  
 Heights 1" Increments

**UPPER CABINETS**

*Carriage House, Fine Kitchen Cabinetry*

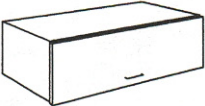
**1.2**

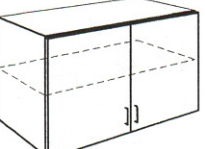
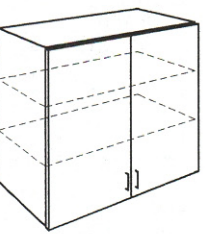
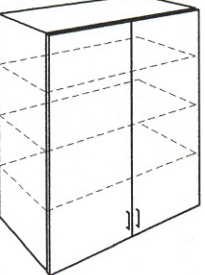
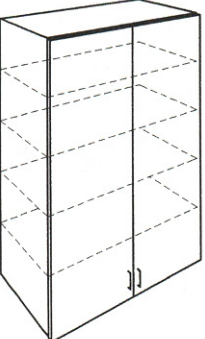

		SHELVES	CODE	W	H	D	PRICE		
	SINGLE LIFTUP DOOR	0	W2412	24	12	12	175		
			W3012	30	12	12	200		
			W3612	36	12	12	250		
			W4212	42	12	12	315		
			W4812	48	12	12	365		
    	PAIRED DOORS	0	W2415	24	15	12	255		
			W3015	30	15	12	275		
			W3615	36	15	12	300		
			W4215	42	15	12	325		
			W4815	48	15	12	365		
			W2418	24	18	12	290		
			W3018	30	18	12	305		
			W3618	36	18	12	320		
			W4218	42	18	12	335		
			W4818	48	18	12	350		
			1	W2424	24	24	12	310	
				W3024	30	24	12	330	
				W3624	36	24	12	355	
				W4224	42	24	12	375	
				W4824	48	24	12	415	
				W2430	24	30	12	335	
				W3030	30	30	12	355	
				W3630	36	30	12	380	
				W4230	42	30	12	400	
				W4830	48	30	12	440	
				2	W2436	24	36	12	400
					W3036	30	36	12	420
					W3636	36	36	12	440
					W4236	42	36	12	465
			W4836	48	36	12	486		
			3	W2442	24	42	12	450	
				W3042	30	42	12	465	
				W3642	36	42	12	480	
				W4242	42	42	12	500	
				W4842	48	42	12	520	
			4	W2460	24	60	12	675	
				W3060	30	60	12	700	
				W3660	36	60	12	720	
				W4260	42	60	12	750	
				W4860	48	60	12	770	

Additional Depths 12" to 15" add 10%  
 15" to 18" add 15%  
 18" to 21" add 20%

Interior Options Black and Almond Melamine - add 10% of case  
 Stock Melamine Colors - add 25% of case  
 Finished Wood and other Melamine Colors - Double price of case

Additional Melamine Shelves - MS - \$25 each

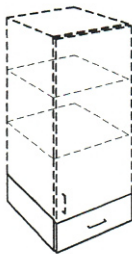
Fractions Add \$125 per cabinet  
 Custom Items Add 30% to cabinet price  
 Heights 1" Increments

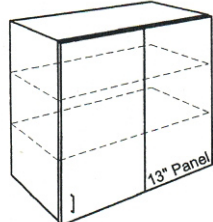
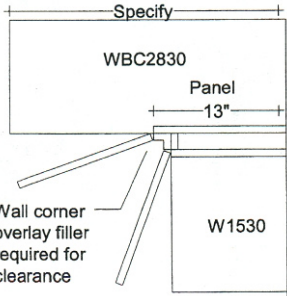
	SHELVES	CODE	W	H	D	PRICE
 <p><b>WALL DRAWER</b></p> <ul style="list-style-type: none"> <li>•Full Extension Glides Included</li> <li>•Add Drawer Front</li> <li>•Add for Multiple Drawers</li> <li>•Add for Multiple Drawer Fronts</li> </ul> 		DRAWER				150 EACH
		DRAWER MF				150 44 EACH FRONT
 <p><b>MULTIPLE FRONTS</b></p> <p>When using more than one front on a drawer or door the fronts need to be splined together to appear as one.</p>		MF				44 EACH FRONT  ADD FOR RAISED PANEL FRONTS
 <p><b>WALL BLIND CORNER</b></p> <ul style="list-style-type: none"> <li>•Specify Left or Right (left illustrated)</li> </ul>  <p>The overall width dimension of WBC's does not include a void space.</p> <p>WBC panel is 13" wide</p>	1	WBC2724	27	24	12	350
		WBC3624	36	24	12	370
		WBC3924	39	24	12	520
		WBC4524	45	24	12	550
	1	WBC2730	27	30	12	400
		WBC3630	36	30	12	420
		WBC3930	39	30	12	570
		WBC4530	45	30	12	600
	1	WBC2724	27	39	12	460
		WBC3624	36	39	12	480
		WBC3924	39	39	12	630
		WBC4524	45	39	12	660
	1	WBC2748	27	48	12	570
	WBC3648	36	48	12	590	
	WBC3948	39	48	12	740	
	WBC4548	45	48	12	770	

Additional Depths 12" to 15" add 10%  
 15" to 18" add 15%  
 18" to 21" add 20%

Fractions Add \$125 per cabinet  
 Custom Items Add 30% to cabinet price  
 Heights 1" Increments

Interior Options Black and Almond Melamine - add 10% of case  
 Stock Melamine Colors - add 25% of case  
 Finished Wood and other Melamine Colors - Double price of case

Additional Melamine Shelves - MS - \$25 each

**UPPER CABINETS**

*Carriage House, Fine Kitchen Cabinetry*

**1.4**

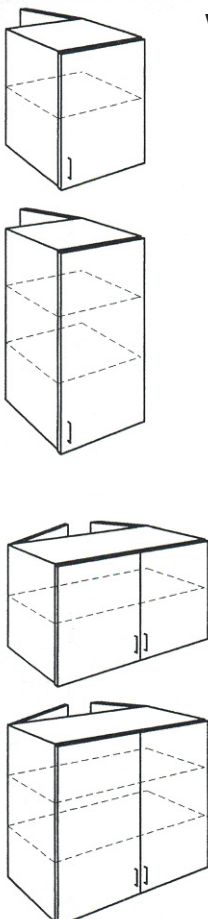
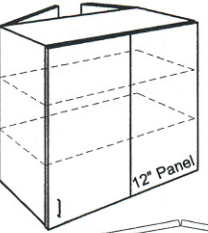
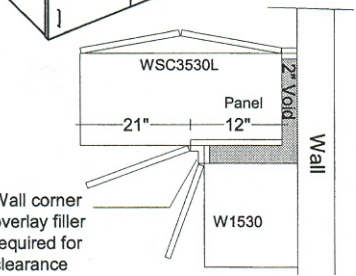
		SHELVES	CODE	W	H	D	PRICE
 <p><b>WALL DOUBLE ENTRY</b></p> <ul style="list-style-type: none"> <li>•Single Door</li> <li>•Specify Left or Right Hinge</li> </ul>	0	WDE0918 WDE1518 WDE2418	9 18 12 15 18 12 24 18 12	260 305 360			
	1	WDE0924 WDE1524 WDE2424	9 24 12 15 24 12 24 24 12	260 350 360			
	2	WDE0930 WDE1530 WDE2430	9 30 12 15 30 12 24 30 12	275 320 375			
	3	WDE936 WDE1536 WDE2436	9 36 12 15 36 12 24 36 12	300 350 400			
	0	WDE2418 WDE3018 WDE3618	24 18 12 30 18 12 36 18 12	385 435 485			
	1	WDE2424 WDE3024 WDE3624	24 24 12 30 24 12 36 24 12	385 435 485			
	2	WDE2430 WDE3030 WDE3630	24 30 12 30 30 12 36 30 12	400 450 500			
	3	WDE2436 WDE3036 WDE3636	24 36 12 30 36 12 36 36 12	425 475 525			
	 <p><b>WALL DOUBLE ENTRY</b> •BLIND CORNER</p> <p>Specify Left or Right Hinge (Left Illustrated)</p> 	2	WDEBC2730 WDEBC3030 WDEBC3330 WDEBC3630	27 30 12 30 30 12 33 30 12 36 30 12	450 500 550 600		
		2	WDEBC2736 WDEBC3036 WDEBC3336 WDEBC3636	27 36 12 30 36 12 33 36 12 36 36 12	475 525 575 625		

Additional Depths 12" to 15" add 10%  
 15" to 18" add 15%  
 18" to 21" add 20%

Fractions Add \$125 per cabinet  
 Custom Items Add 30% to cabinet price  
 Heights 1" Increments

Interior Options Black and Almond Melamine - add 10% of case  
 Stock Melamine Colors - add 25% of case  
 Finished Wood and other Melamine Colors - Double price of case

Additional Melamine Shelves - MS - \$25 each

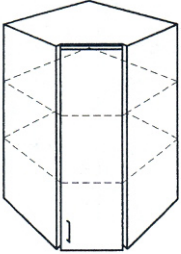
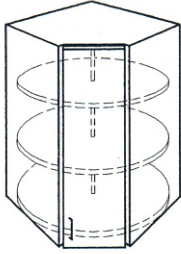
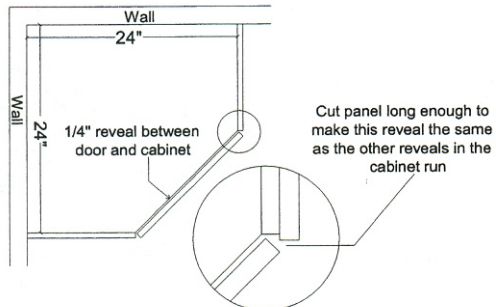
	SHELVES	CODE	W	H	D	PRICE	
 <p><b>WALL CORNER 45</b></p> <ul style="list-style-type: none"> <li>•Single door</li> <li>•Specify Left or Right Hinge</li> </ul>  <p>Add for three (3) 18” polymer Lazy Susan shelves</p> 	1	WSC2424	24	24	12	580	
	2	WSC2430	24	30	12	600	
	3	WSC2448	24	48	12	640	
			WSC27x	27			ADD 65
			LSR18				450
	1	WCD3024	30	24	30	550	
	2	WCD3030	30	24	30	550	
		WCD3036	30	36	30	610	
	3	WCD3042	30	42	30	640	
		WCD3048	30	48	30	670	

**Wall corner Cabinet and Lazy Susan Notes**

1. Wall corner cabinets have a single 45° angled door.
2. Wall corner cabinets can be routed for glass but are NOT suitable for internal lighting due to the reveal around the door.
3. Use a 3/4” end panel to finish a wall corner cabinet which does not have another cabinet next to it.
4. When using end panels, make sure to cut the panel as close as possible to the door so the reveal will be equal to the other reveals in the cabinet run (see diagram).
5. Due to the mechanical properties of the special hardware, in some applications the reveals on each side of the door may exceed the normal 1/8”.

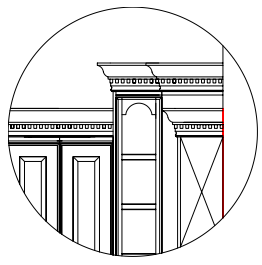

Add 10% if corner wall cabinet is taller than adjacent cabinets

Additional Depths	12” to 15” add 10%	Fractions	Add \$125 per cabinet
	15” to 18” add 15%	Custom Items	Add 30% to cabinet price
	18” to 21” add 20%	Heights	1” Increments
Interior Options	Black and Almond Melamine - add 10% of case		
	Stock Melamine Colors - add 25% of case		
	Finished Wood and other Melamine Colors - Double price of case		
Additional Melamine Shelves	- MS - \$25 each		

**UPPER CABINETS**

*Carriage House, Fine Kitchen Cabinetry*

**1.6**

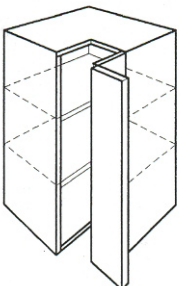
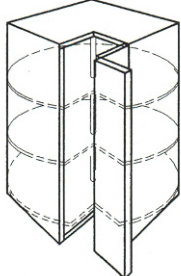
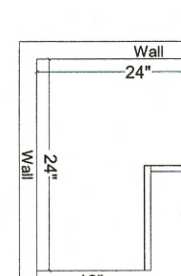
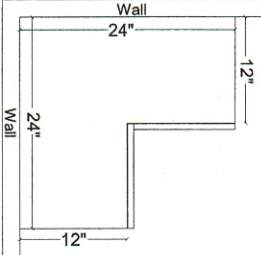
	SHELVES	CODE	W	H	D	PRICE
 <p><b>WALL CORNER 90</b></p> <ul style="list-style-type: none"> <li>•Continuous Door</li> <li>•Specify Left or Right Hinge</li> </ul>  <p>Add for two (2) 18" polymer Lazy Susan shelves</p>  <p>Add for three (3) 18" polymer Lazy Susan shelves</p> 	1	WSC2424	24	24	12	580
	2	WSC2430	24	30	12	600
	3	WSC2448	24	48	12	640
		WSC27x	27			ADD 65
		LSR18				400
		LS3R18				450

Additional Depths    12" to 15" add 10%  
                              15" to 18" add 15%  
                              18" to 21" add 20%

Interior Options Black and Almond Melamine - add 10% of case  
 Stock Melamine Colors - add 25% of case  
 Finished Wood and other Melamine Colors - Double price of case

Additional Melamine Shelves - MS - \$25 each

Fractions            Add \$125 per cabinet  
 Custom Items    Add 30% to cabinet price  
 Heights 1" Increments

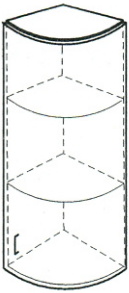
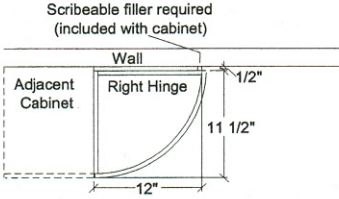
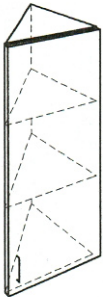
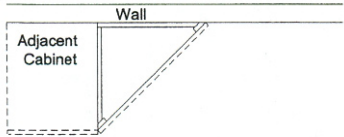
	SHELVES	CODE	W	H	D	PRICE
 <p><b>WALL CORNER RADIUS END</b></p> <ul style="list-style-type: none"> <li>•Specify Left or Right Hinge</li> <li>•Style Limitations</li> <li>•3/4 x 3/4 Filler included</li> </ul>	1	WCR1230	12	30	12	500
	3	WCR1248	12	48	12	600
<p>Scribeable filler required (included with cabinet)</p>  <p>Wall Corner Radius Ends</p> <p>Custom widths and depths are available Door has 10" radius and is hinged to the back of the cabinet</p>						
 <p><b>WALL ANGLE 45</b></p> <p>Specify Left or Right Hinge</p>	1	WA451230	12	30	12	450
	2	WA451242	12	42	12	550
	3	WA451260	12	60	12	650
	1	WA452430	24	30	24	550
	2	WA452442	24	42	24	650
	3	WA452460	24	60	24	750
						

Additional Depths    12" to 15" add 10%  
                              15" to 18" add 15%  
                              18" to 21" add 20%

Fractions            Add \$125 per cabinet  
 Custom Items      Add 30% to cabinet price  
 Heights 1" Increments

Interior Options Black and Almond Melamine - add 10% of case  
 Stock Melamine Colors - add 25% of case  
 Finished Wood and other Melamine Colors - Double price of case

Additional Melamine Shelves - MS - \$25 each

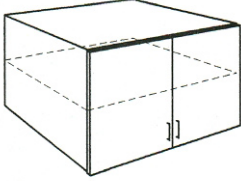
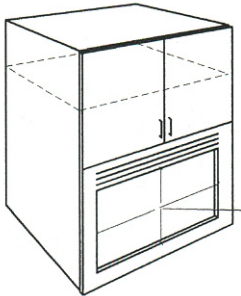
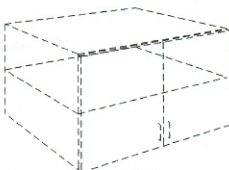
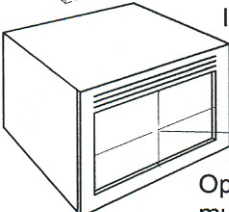
		SHELVES	CODE	W	H	D	PRICE
 <p><b>WALL REFRIGERATOR</b></p> <p>•Paired Doors 24" Deep</p> <p>When used with Sub Zero there is no charge for fractions</p> <p>•25" to 30" Deep</p>	1	WR3624	36	24	24	375	
		WR4224	42	24	24	400	
		WR4824	48	24	24	425	
		WR3630	36	30	24	410	
		WR4230	42	30	24	435	
		WR4830	48	30	24	460	
							ADD 30%
 <p><b>WALL MICROWAVE*</b></p> <p>Opening size must be shown</p>	1	WM2742	27	42	18	535	
		WM3042	30	42	18	555	
	2	WM2748	27	48	18	585	
		WM3048	30	48	18	615	
	3	WM2760	27	60	18	745	
		WM3060	30	60	18	765	
<p><b>MICROWAVE WOOD INTERIOR*</b></p>  <p><b>Upper Cabinet Not Included</b></p> <p>Includes Wood Interior Includes Face Frame</p> <p>Maximum Size 30" Wide 24" High 21" Deep</p>  <p>Opening size must be shown</p>		MWI				780	
<p><b>MICROWAVE FACE FRAME ONLY*</b></p> <p>*All microwave frames are vented at the top and have an edge detail to match door detail.</p>		OFM				120	

Interior Options Black and Almond Melamine - add 10% of case  
 Stock Melamine Colors - add 25% of case  
 Finished Wood and other Melamine Colors - Double price of case  
 Additional Melamine Shelves - MS - \$25 each

Fractions Add \$125 per cabinet  
 Custom Items Add 30% to cabinet  
 Heights 1" Increments



**UPPER CABINETS**

*Carriage House, Fine Kitchen Cabinetry*

**1.9**

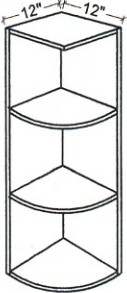
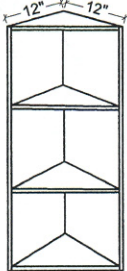
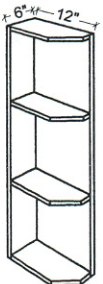
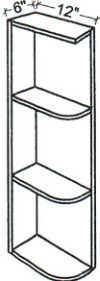
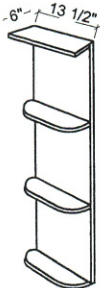
		SHELVES	CODE	W	H	D	PRICE
	WALL ROUNDED						
	Open Cabinet	1	WROC30	12	30	12	350
	No Face Frame	2	WROC48	12	48	12	450
	Included Wood Interior	3	WROC60	12	60	12	550
	WALL ANGLE						
	Open Cabinet	1	WAOC30	12	30	12	350
	No Face Frame	2	WAOC48	12	48	12	450
	Included Wood Interior	3	WAOC60	12	60	12	550
	WALL ANGLE						
	Open Cabinet	1	WAOC30	12	30	12	350
	No Face Frame	2	WAOC48	12	48	12	450
	Included Wood Interior	3	WAOC60	12	60	12	550
	WALL ROUNDED						
	Open Cabinet	1	WROC30	6	30	12	350
	No Face Frame	2	WROC48	6	48	12	450
	Included Wood Interior	3	WROC60	6	60	12	550
	WALL END ROUNDED						
	Open Cabinet	1	WEROC30	6	30	13½	350
	No Face Frame	2	WEROC48	6	48	13½	450
	Included Wood Interior	3	WEROC60	6	60	13½	550

Additional Depths      12" to 15" add 10%  
                                  15" to 18" add 15%  
                                  18" to 21" add 20%

Heights 1" Increments

**UPPER CABINETS**

*Carriage House, Fine Kitchen Cabinetry*

**1.10**

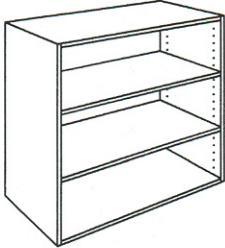
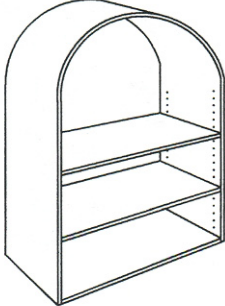
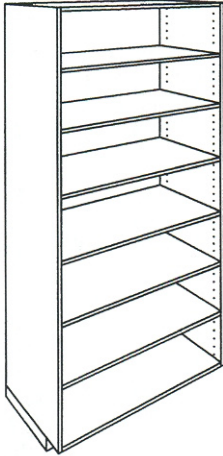
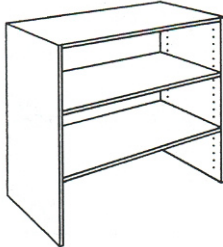
		SHELVES	CODE	W	H	D	PRICE
 <p><b>WALL OPEN SHELVES</b> Wood Interior WOS are not available with face frame or 1½” shelves</p>			WOS				PRICE AS WALL CAB
			WI				PRICE 2X WALL CAB
 <p><b>ARCHED CABINET</b> Wood Interior</p>			ARCHED				ADD 600 TO PRICE
			WI				PRICE 2X WALL CAB
 <p><b>BOOKCASE</b></p> <p>BK 12” to 30” - ¾” shelf with ½” trim BK 31” to 48” - 1½” shelf with ½” trim Face Frame included with matching edge BK under 6 sq. ft. price 120 per sq. ft.</p>			BK12			12	80
			BK15			15	85
			BK18			18	90
			BK24			24	100
			BK27			27	115
			BK30			30	130
 <p><b>BOOKCASE OPEN BOTTOM</b> •This bookcase sits on the top of a deck</p>			BKOB				DEDUCT 50 OFF BOOKCASE PRICE
<b>ADD FOR BEAD BOARD BACKS</b>			BKBEAD				20 PER SQ. FT.

**UPPER CABINETS**

*Carriage House, Fine Kitchen Cabinetry*

**1.11**

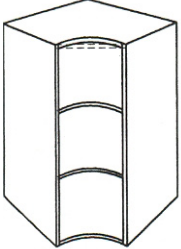
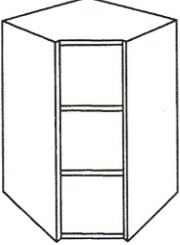
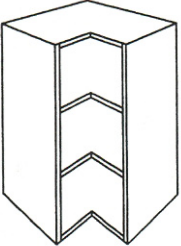
		SHELVES	CODE	W	H	D	PRICE
 <p><b>WALL CORNER OPEN RADIUS*</b></p> <p>•Includes wood interior without face frame</p>	1	WCOR2424	24	24	12	550	
	2	WCOR2430	24	30	12	650	
		WCOR2439	24	39	12	750	
	3	WCOR2448	24	48	12	950	
		WCOR27x				ADD 65	
 <p><b>WALL CORNER OPEN 45*</b></p> <p>•Includes wood interior without face frame</p>	1	WCOD2424	24	24	12	550	
	2	WCOD2430	24	30	12	650	
		WCOD2439	24	39	12	750	
	3	WCOD2448	24	48	12	950	
		WCOD27x				ADD 65	
 <p><b>WALL CORNER OPEN 90*</b></p> <p>•Includes wood interior without face frame</p>	1	WCOS2424	24	24	12	600	
	2	WCOS2430	24	30	12	700	
		WCOS2439	24	39	12	800	
	3	WCOS2448	24	48	12	1000	
		WCOS27x				ADD 65	

\*Specify angled top if crown mold is used

Additional Depths	12" to 15" add 10%	Fractions	Add \$125 per cabinet
	15" to 18" add 15%	Custom Items	Add 30% to cabinet price
	18" to 21" add 20%	Heights	1" Increments
Interior Options	Black and Almond Melamine - add 10% of case		
	Stock Melamine Colors - add 25% of case		
	Finished Wood and other Melamine Colors - Double price of case		
Additional Melamine Shelves - MS - \$25 each			

**UPPER CABINETS**

*Carriage House, Fine Kitchen Cabinetry*

**1.12**

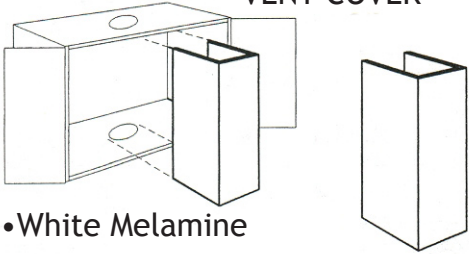
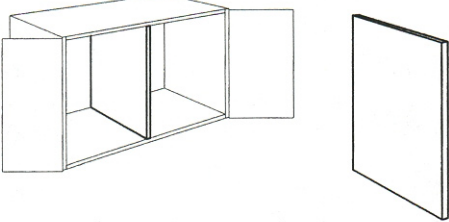
	SHELVES	CODE	W	H	D	PRICE
<p><b>VENT COVER</b></p>  <p>•White Melamine</p>		VENT				25 PER SQ. FT.
<p><b>DIVIDER WALL</b></p> 		DIVW				75

Additional Depths      12" to 15" add 10%  
                                  15" to 18" add 15%  
                                  18" to 21" add 20%

Interior Options Black and Almond Melamine - add 10% of case  
 Stock Melamine Colors - add 25% of case  
 Finished Wood and other Melamine Colors - Double price of case

Additional Melamine Shelves - MS - \$25 each

Fractions              Add \$125 per cabinet  
 Custom Items        Add 30% to cabinet price  
 Heights 1" Increments

**UPPER CABINETS**

*Carriage House, Fine Kitchen Cabinetry*

**1.13**

	SHELVES	CODE	W	H	D	PRICE
CUSTOM ITEMS See General Manager or Assistant General Manager for cabinet price.						30%
MIXED COLORS IN SINGLE CABINET When mixing more than one color on one cabinet: add 35% to cabinet price						50%
MIXED COLORS IN SINGLE CABINET When mixing more than two colors in one room: add 75% to cabinet price of all cabinets of the 3rd, 4th, etc. color						75%
HARDWARE When pulls are drilled on job site: add 4.00 per pull						4

Additional Depths      12" to 15" add 10%      Fractions      Add \$125 per cabinet  
                                  15" to 18" add 15%      Custom Items      Add 30% to cabinet price  
                                  18" to 21" add 20%      Heights 1" Increments

Interior Options Black and Almond Melamine - add 10% of case  
 Stock Melamine Colors - add 25% of case  
 Finished Wood and other Melamine Colors - Double price of case

Additional Melamine Shelves - MS - \$25 each



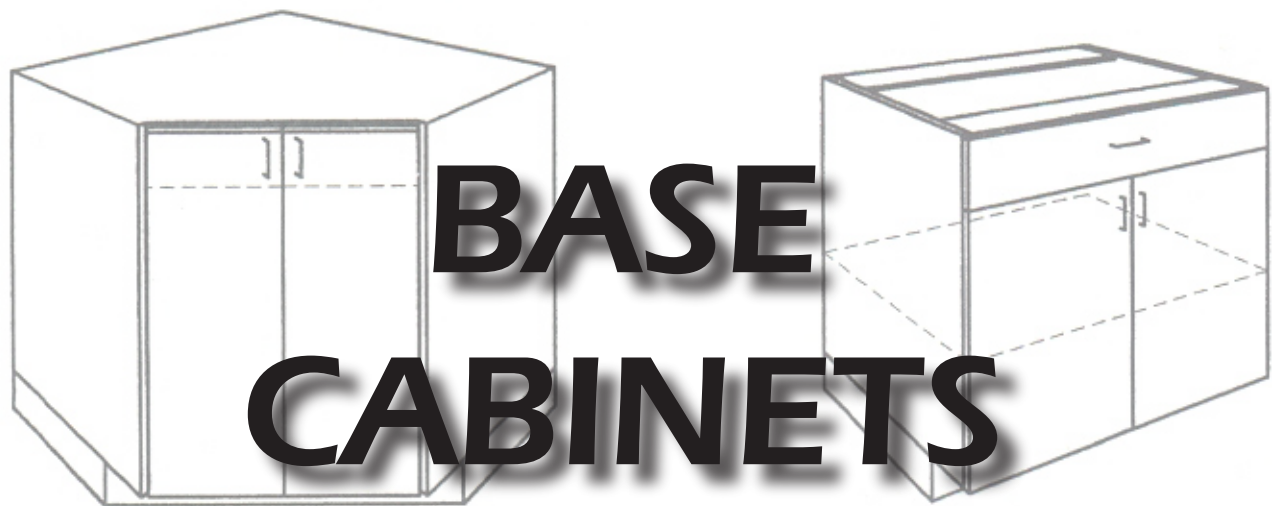

*Carriage House*  
*Fine Kitchen Cabinetry*





**BASE CABINETS**

*Carriage House, Fine Kitchen Cabinetry*

**2.1**

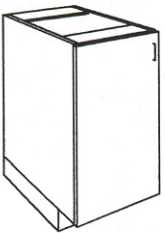
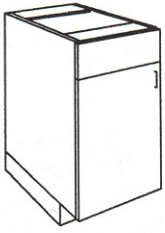
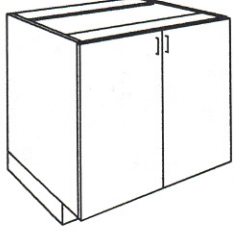
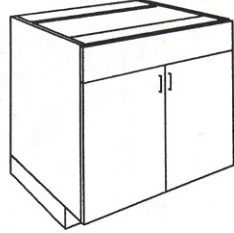
		SHELVES	CODE	W	H	D	PRICE
 <p><b>BASE SINK</b> •Single Door Specify Left or Right Hinge</p>	0		BS12	12	30	24	220
			BS18	18	30	24	240
			BS24	24	30	24	260
 <p><b>BASE SINK</b> •Single Door Specify Left or Right Hinge •False Front</p>	WITHOUT TIPOUTS		BS1F18	18	30	24	330
			BS1F24	24	30	24	365
	WITH TIPOUTS		BS1FT18	18	30	24	365
			BS1FT24	24	30	24	400
 <p><b>BASE SINK</b> •Paired Doors</p>	0		BS24	24	30	24	300
			BS30	30	30	24	325
			BS36	36	30	24	350
			BS42	42	30	24	370
			BS48	48	30	24	390
 <p><b>BASE SINK</b> •Paired Doors •False Front</p>	WITHOUT TIPOUTS		BS1F24	24	30	24	395
			BS1F30	30	30	24	425
			BS1F36	36	30	24	455
			BS1F42	42	30	24	475
			BS1F48	48	30	24	500
	WITH TIPOUTS		BS1FT24	24	30	24	430
			BS1FT30	30	30	24	450
			BS1FT36	36	30	24	470
			BS1FT42	42	30	24	510
			BS1FT48	48	30	24	550

Case Height: 30"      Overall Height: 34-1/2"      Custom Height: Add 20%  
 Additional Depths      25" to 27" add 10%      Fractions      Add \$125 per cabinet  
                                  29" to 30" add 15%      Custom Items      Add 30% to cabinet price  
                                  31" to 33" add 20%

Interior Options Black and Almond Melamine - add 10% of case  
 Stock Melamine Colors - add 25% of case  
 Finished Wood and other Melamine Colors - Double price of case

Additional Melamine Shelves - MS - \$25 each

**BASE CABINETS**

*Carriage House, Fine Kitchen Cabinetry*

**2.2**

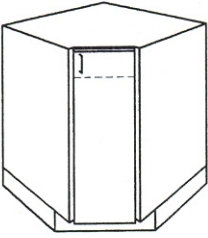
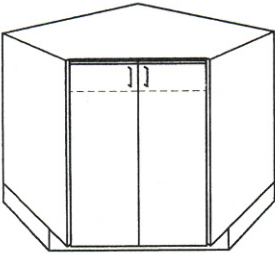
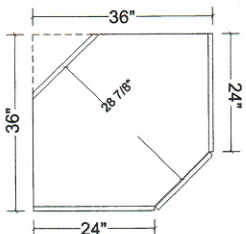
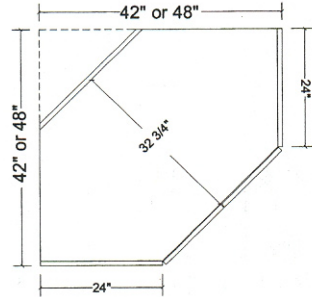
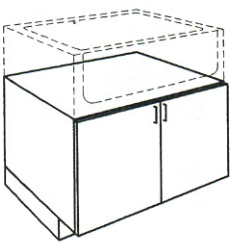
	SHELVES	CODE	W	H	D	PRICE
 <p><b>BASE CORNER SINK 45</b></p> <ul style="list-style-type: none"> <li>•Single Door</li> <li>Specify Left or Right Hinge</li> </ul>	0	BCS3645	36	30	24	550
 <p><b>BASE CORNER SINK 45</b></p> <ul style="list-style-type: none"> <li>•Paired Doors</li> </ul>	0	BCS4245 BCS4845	42 48	30	24	650 750
<p>Base Corner Sink Cabinets are available with full height doors</p> <p>a. 36" cabinet has single door hinged LEFT or RIGHT</p> <p>b. 42" and 48" cabinets have paired doors</p> <p>Corner Sink Cabinets are NOT available with tilt-out front</p> <div style="display: flex; justify-content: space-around;"> <div style="text-align: center;">  <p>Base Corner Sink BCS3645</p> </div> <div style="text-align: center;">  <p>Base Corner Sink BCS4245 BCS4845</p> </div> </div>						
 <p><b>BASE FARM SINK</b></p> <ul style="list-style-type: none"> <li>•Paired Doors</li> </ul>	0	BFS30 BFS33 BFS36 BFS39 BFS42	30 33 36 39 42	*	24	525 550 575 600 625

\*Specify Height

Case Height: 30"      Overall Height: 34-1/2"      Custom Height: Add 20%

Additional Depths      25" to 27" add 10%      Fractions      Add \$125 per cabinet

                                 29" to 30" add 15%      Custom Items      Add 30% to cabinet price

                                 31" to 33" add 20%

Interior Options Black and Almond Melamine - add 10% of case

                                 Stock Melamine Colors - add 25% of case

                                 Finished Wood and other Melamine Colors - Double price of case

Additional Melamine Shelves - MS - \$25 each

**BASE CABINETS**

*Carriage House, Fine Kitchen Cabinetry*

**2.3**

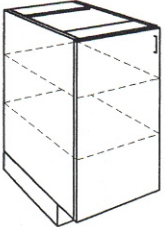
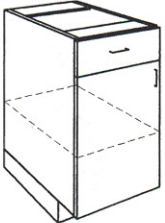
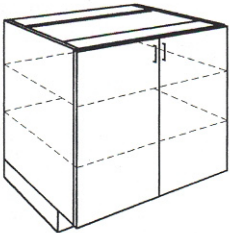
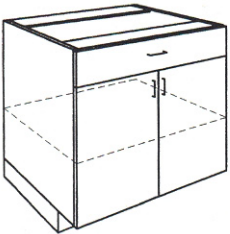
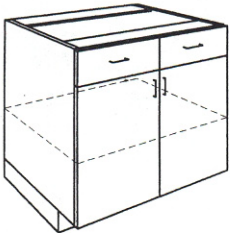
		SHELVES	CODE	W	H	D	PRICE
 <p><b>BASE CABINET</b> •Single Door Specify Left or Right Hinge</p>	2		BS12	12	30	24	270
			BS18	18	30	24	290
			BS24	24	30	24	310
 <p><b>BASE CABINET</b> •Single Door Specify Left or Right Hinge •One Drawer</p> <p>Add for extra Drawers</p>	1		B112	12	30	24	370
			B118	18	30	24	395
			DRAWER	24	30	24	420
			DRAWER				150
 <p><b>BASE CABINET</b> •Paired Doors</p>	2		B24	24	30	24	350
			B30	30	30	24	375
			B36	36	30	24	400
			B42	42	30	24	420
			B48	48	30	24	440
 <p><b>BASE CABINET</b> •Paired Doors •One Drawer Drawers over 36" will have Heavy Duty Full-Extention Glides</p> <p>•Add for extra Drawers</p>	1	INCLUDES FEG	B124	24	30	24	460
			B130	30	30	24	480
			B136	36	30	24	500
			B137	37	30	24	570
			B142	42	30	24	590
						DRAWER	
 <p><b>BASE CABINET</b> •Paired Doors •2 Drawers</p> <p>Add for extra Drawers</p>	1		B230	30	30	24	630
			B236	36	30	24	650
			B242	42	30	24	670
			B248	48	30	24	690
						DRAWER	

Case Height: 30"      Overall Height: 34-1/2"      Custom Height: Add 20%

Additional Depths      25" to 27" add 10%      Fractions      Add \$125 per cabinet

                                 29" to 30" add 15%      Custom Items      Add 30% to cabinet price

                                 31" to 33" add 20%

Interior Options Black and Almond Melamine - add 10% of case

                                 Stock Melamine Colors - add 25% of case

                                 Finished Wood and other Melamine Colors - Double price of case

Additional Melamine Shelves - MS - \$25 each

**BASE CABINETS**

*Carriage House, Fine Kitchen Cabinetry*

**2.4**

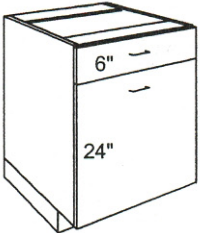
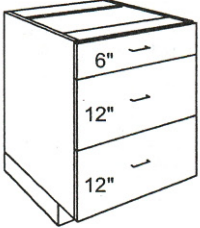
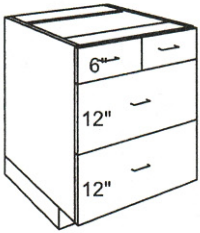
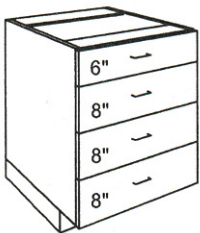
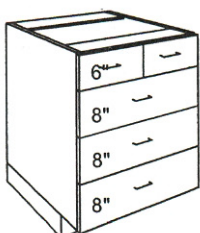
	<b>DRAWERS</b>	<b>CODE</b>	<b>W</b>	<b>H</b>	<b>D</b>	<b>PRICE</b>	
 <p><b>BASE CABINET</b> • 2 Drawers</p> <p>• Designed for Pull-Out Trash Add \$100 for full sides on bottom drawer</p>	2	BPO12	12	30	24	600	
		BPO18	18	30	24	630	
		BPO24	24	30	24	660	
 <p><b>BASE DRAWER</b> • 3 Drawers*</p>	3	B12D3	12	30	24	550	
		B18D3	18	30	24	570	
		B24D3	24	30	24	610	
		B30D3	30	30	24	670	
		B36D3	36	30	24	730	
		INCLUDES FEG*	B37D3	37	30	24	860
			B42D3	42	30	24	880
B48D3	48		30	24	970		
 <p><b>BASE DRAWER</b> • 2 Top Drawers • 2 Bottom Drawers*</p>	4	B4DS24	24	30	24	830	
		B4DS30	30	30	24	855	
		B4DS36	36	30	24	895	
		INCLUDES FEG*	B4DS37	37	30	24	955
			B4DS42	42	30	24	975
			B4DS48	48	30	24	1015
			 <p><b>BASE DRAWER</b> • 4 Drawers*</p>	4	B12D4	12	30
B18D4	18	30			24	640	
B24D4	24	30			24	680	
B30D4	30	30			24	740	
B36D4	36	30			24	800	
INCLUDES FEG*	B37D4	37			30	24	920
	B42D4	42			30	24	950
	B48D4	48	30	24	1000		
	 <p><b>BASE CABINET</b> • 2 Top Drawers • 3 Bottom Drawers*</p>	5	B5DS24	24	30	24	1030
B5DS30			30	30	24	1055	
B5DS36			36	30	24	1095	
INCLUDES FEG*			B5DS37	37	30	24	1225
			B5DS42	42	30	24	1245
			B5DS48	48	30	24	1265
			*Drawers over 36" will have Heavy Duty Full-Extension Glides				

Case Height: 30"  
Additional Depths

Overall Height: 34-1/2"  
25" to 27" add 10%  
29" to 30" add 15%  
31" to 33" add 20%

Custom Height: Add 20%  
Fractions Add \$125 per cabinet  
Custom Items Add 30% to cabinet price

Interior Options Black and Almond Melamine - add 10% of case  
Stock Melamine Colors - add 25% of case  
Finished Wood and other Melamine Colors - Double price of case  
Additional Melamine Shelves - MS - \$25 each

**BASE CABINETS**

*Carriage House, Fine Kitchen Cabinetry*

**2.5**

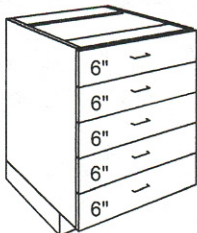
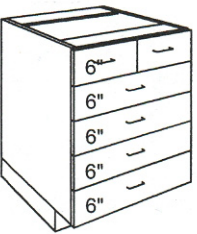
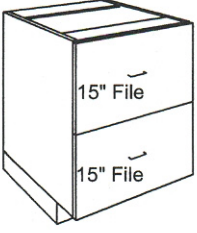
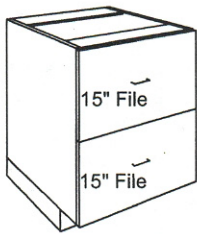
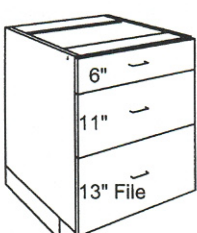
	<b>DRAWERS</b>	<b>CODE</b>	<b>W</b>	<b>H</b>	<b>D</b>	<b>PRICE</b>	
 <p><b>BASE DRAWER</b> •5 Drawers*</p>	5	B12D5	12	30	24	700	
		B18D5	18	30	24	720	
		B24D5	24	30	24	750	
		B30D5	30	30	24	800	
		B36D5	36	30	24	860	
		INCLUDES FEG*	B37D5	37	30	24	1120
 <p><b>BASE DRAWER</b> •2 Top Drawers* •4 Bottom Drawers*</p> <p>Add for extra Drawers</p>	6	B6DS24	24	30	24	1230	
		B6DS30	30	30	24	1255	
		B6DS36	36	30	24	1295	
		INCLUDES FEG*	B6DS37	37	30	24	1495
		B6DS42	42	30	24	1515	
		B6DS48	48	30	24	1535	
 <p><b>BASE FILE</b> •2 File Drawers</p> <p>17" wide minimum cabinet for letter 20" wide minimum cabinet for legal</p> <p>Includes Full Extension Heavy Duty Glides Includes 1 File rack in each drawer</p>	2	BF17D2	17	30	24	580	
		BF18D2	18	30	24	600	
		BF21D2	21	30	24	620	
		BF24D2	24	30	24	640	
 <p><b>BASE FILE LATERAL</b> •2 File Drawers</p> <p>18" deep minimum cabinet for letter 21" deep minimum cabinet for legal</p> <p>Includes Full Extension Heavy Duty Glides Includes 1 File rack in each drawer</p>	2	BFL15D2	15	30	24	580	
		BFL18D2	18	30	24	600	
		BFL21D2	21	30	24	620	
		BFL24D2	24	30	24	640	
		BFL27D2	27	30	24	660	
		BFL30D2	30	30	24	680	
		BFL36D2	36	30	24	750	
		BFL42D2	42	30	24	780	
		 <p><b>BASE FILE 3 DRAWER</b> •2 Drawers •1 File Drawer</p> <p>Includes Full Extension Heavy Duty Glides Includes 1 File rack in each drawer</p>	3	BF17D3	17	30	24
BF18D3	18			30	24	730	
BF24D3	24			30	24	760	
BF30D3	30			30	24	790	
BF36D3	36			30	24	850	
BF42D3	42			30	24	880	
<p>*Drawers over 36" will have Heavy Duty Full-Extension Glides</p>							

Case Height: 30"  
Additional Depths

Overall Height: 34-1/2"  
25" to 27" add 10%  
29" to 30" add 15%  
31" to 33" add 20%





Custom Height: Add 20%  
Fractions Add \$125 per cabinet  
Custom Items Add 30% to cabinet price

Interior Options Black and Almond Melamine - add 10% of case  
Stock Melamine Colors - add 25% of case  
Finished Wood and other Melamine Colors - Double price of case  
Additional Melamine Shelves - MS - \$25 each

**BASE CABINETS**

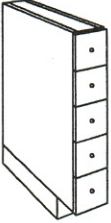
*Carriage House, Fine Kitchen Cabinetry*

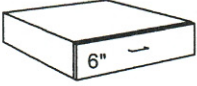
**2.6**

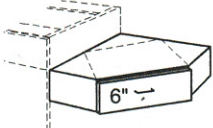
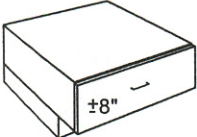

	DRAWERS	CODE	W	H	D	PRICE
 <p><b>BASE ORGANIZER</b> •Slides not included.</p> <p>Add \$150 per drawer Add for drawer fronts</p>	0	BO 6 DRAWER	6	30	24	200 150
 <p><b>MULTIPLE FRONTS</b> •When using more than one front on a drawer or door the fronts need to be splined together to appear as one.</p>		MF				44 EACH FRONT Add for Raised Panel Fronts
 <p><b>BASE DRAWER</b> •Suspended Drawer Single</p>	1	BDS124 BDS130	24 30	6 6	24 24	230 250
 <p><b>BASE DRAWER</b> •Suspended Drawer Double</p>	2	BDS230 BDS236 BDS242 BDS248	30 36 42 48	6 6 6 6	24 24 24 24	390 420 450 470
 <p><b>BASE DRAWER</b> •Suspended Corner</p>	1	BDSA121 BDSA124	21 24	6 6	21 24	300 330
 <p><b>BASE PEDESTAL</b> •1 Drawer</p>	1	BPD124 BPD130 BPD136	24 30 36	* * *	24 24 24	330 350 370

Case Height: 30"      Overall Height: 34-1/2"      Custom Height: Add 20%  
 Additional Depths      25" to 27" add 10%      Fractions      Add \$125 per cabinet  
                                  29" to 30" add 15%      Custom Items      Add 30% to cabinet price  
                                  31" to 33" add 20%  
 Interior Options Black and Almond Melamine - add 10% of case  
                                  Stock Melamine Colors - add 25% of case  
                                  Finished Wood and other Melamine Colors - Double price of case  
 Additional Melamine Shelves - MS - \$25 each

**BASE CABINETS**

*Carriage House, Fine Kitchen Cabinetry*

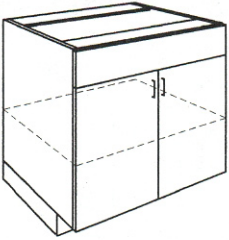
**2.7**

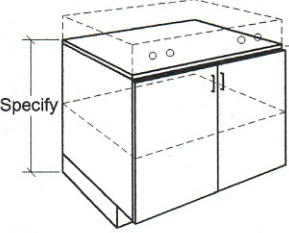
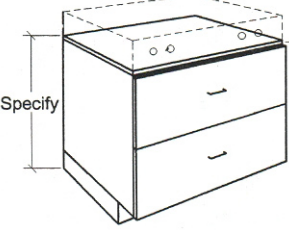
		SHELVES	CODE	W	H	D	PRICE
 <p><b>BASE RANGE</b></p> <ul style="list-style-type: none"> <li>• False Front</li> <li>• Paired Doors</li> </ul>	1		BR1F30	30	30	24	375
			BR1F36	36	30	24	400
			BR1F42	42	30	24	420
			BR1F48	48	30	24	440
 <p><b>BASE RANGE</b></p> <ul style="list-style-type: none"> <li>• False Front</li> <li>• 2 Drawers - Includes Heavy-Duty Glides</li> </ul>			BR1F30D2	30	30	24	680
			BR1F36D2	36	30	24	700
			BR1F42D2	42	30	24	740
			BR1F48D2	48	30	24	760
<p>27" Deep</p>  <p><b>BASE VENT</b></p> <ul style="list-style-type: none"> <li>• 3 Drawers</li> <li>• Cook &amp; Vent Includes Heavy-Duty Glides</li> </ul> <p>See Appliance Specs</p>			BV30D3	30	30	27	790
			BV36D3	36	30	27	850
			BV42D3	42	30	27	880
			BV48D3	48	30	27	900
 <p><b>BASE RANGE PEDESTAL</b></p> <ul style="list-style-type: none"> <li>• Paired Doors</li> </ul> <p>Includes a 3/4" finished deck shelf</p> <p>Specify</p>  <p><b>BASE RANGE PEDESTAL</b></p> <ul style="list-style-type: none"> <li>• 2 Drawers</li> </ul> <p>Includes a 3/4" finished deck shelf</p> <p>Includes HD glides</p> <p>Specify</p> <p>Top burner is mounted on top of the pedestal unit. State overall height of the cabinet, including toe kick. Custom heights are available, Standard size unit will be manufactured of custom size is not specified.</p>	1		BRP30	30	30	24	355
			BRP36	36	30	24	380
			BRP42	42	30	24	400
			BRP48	48	30	24	420
			BRP30D2	30	30	24	680
			BRP36D2	36	30	24	700
			BRP42D2	42	30	24	740
			BRP48D2	48	30	24	760

Case Height: 30"      Overall Height: 34-1/2"      Custom Height: Add 20%

Additional Depths      25" to 27" add 10%      Fractions      Add \$125 per cabinet

                                 29" to 30" add 15%      Custom Items      Add 30% to cabinet price

                                 31" to 33" add 20%

Interior Options Black and Almond Melamine - add 10% of case

                                 Stock Melamine Colors - add 25% of case

                                 Finished Wood and other Melamine Colors - Double price of case

Additional Melamine Shelves - MS - \$25 each

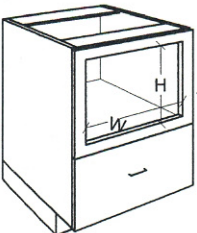
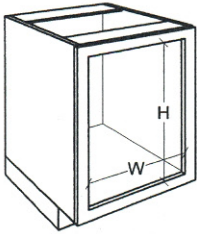
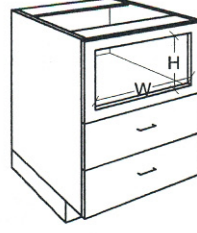
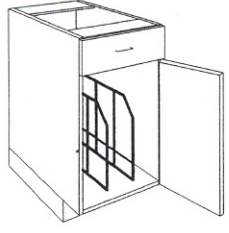
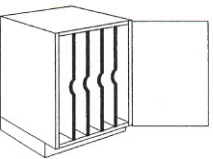
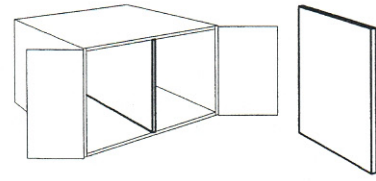
	<b>DRAWERS</b>	<b>CODE</b>	<b>W</b>	<b>H</b>	<b>D</b>	<b>PRICE</b>
 <p><b>BASE MICRO WITH DRAWER</b>                      •1 Drawer                      •Includes Face Frame                      Opening Sizes <b>MUST</b> be shown                      Face Frames are made only from specs.</p>	1	BMD30 BMD36	30 36	30 30	24 24	560 580
	Face Frame Only	OFM				120
 <p><b>BASE OVEN</b>                      •Includes Face Frame                      Opening Sizes <b>MUST</b> be shown                      Face Frames are made only from specs.</p>	0	BOC30 BOC36 BOC39	30 36 39	30 30 30	24 24 24	495 515 620
	Face Frame Only	OFM				120
 <p><b>BASE WARMING DRAWER</b>                      •2 Drawers                      •Includes Heavy Duty Glides                      •Includes Face Frames                      Opening Sizes <b>MUST</b> be shown                      Face Frames are made only from specs.</p>	2	BWD24 BWD30 BWD36	24 30 36	30 30 30	24 24 24	700 720 750
	Face Frame Only	OFM				120
 <p><b>BASE TRAY</b>                      •Approximate 4" spacing between dividers</p> <p>Melamine</p> 		TD				50 EACH
		TDMEL				75 EACH
 <p><b>DIVIDER BASE</b></p>		DIVB				100

Case Height: 30"      Overall Height: 34-1/2"      Custom Height: Add 20%

Additional Depths      25" to 27" add 10%      Fractions      Add \$125 per cabinet

                                 29" to 30" add 15%      Custom Items      Add 30% to cabinet price

                                 31" to 33" add 20%

Interior Options Black and Almond Melamine - add 10% of case  
 Stock Melamine Colors - add 25% of case  
 Finished Wood and other Melamine Colors - Double price of case

Additional Melamine Shelves - MS - \$25 each



**BASE CABINETS**

*Carriage House, Fine Kitchen Cabinetry*

**2.9**

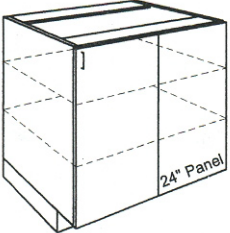
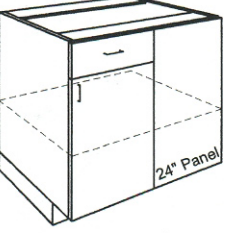
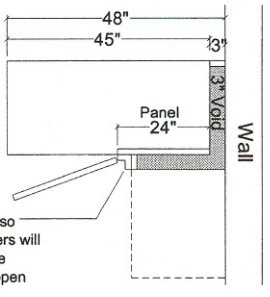
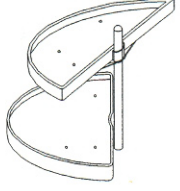
	SHELVES	CODE	W	H	D	PRICE
 <p><b>BLIND CORNER CABINET</b>                      •Single Door                      Specify Left or Right Hinge                      •24" Panel</p> <p><b>Requires a Base Overlay Filler (BCOF)</b></p>	2	BBC39	39	30	24	490
		BBC42	42	30	24	500
		BBC48	48	30	24	520
		BCOF3330				130
 <p><b>BLIND CORNER CABINET</b>                      •Single Door                      Specify Left or Right Hinge                      •24" Panel                      •1 Drawer</p> <p><b>Requires a Base Overlay Filler (BCOF)</b></p>	1	BBC139	39	30	24	550
		BBC142	42	30	24	560
		BBC145	45	30	24	570
		BBC148	48	30	24	580
BCOF3330				130		
 <p>Use a 3" filler so doors &amp; drawers will have adequate clearance to open properly.</p> <p>Beware of appliances in corners!!!</p>						
 <p><b>HALF MOON LAZY SUSAN</b>                      •2 Pul out Shelves</p>	2	LSHM				475

Case Height: 30"  
 Additional Depths

Overall Height: 34-1/2"  
 25" to 27" add 10%  
 29" to 30" add 15%  
 31" to 33" add 20%

Custom Height: Add 20%  
 Fractions Add \$125 per cabinet  
 Custom Items Add 30% to cabinet price

Interior Options Black and Almond Melamine - add 10% of case  
 Stock Melamine Colors - add 25% of case  
 Finished Wood and other Melamine Colors - Double price of case  
 Additional Melamine Shelves - MS - \$25 each

**BASE CABINETS**

*Carriage House, Fine Kitchen Cabinetry*

**2.10**

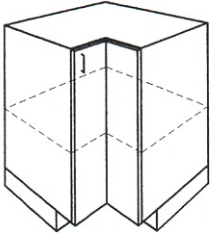
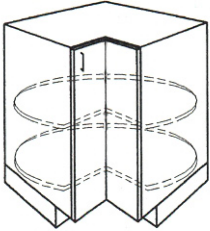
	SHELVES	CODE	W	H	D	PRICE
 <p><b>BASE CORNER 90</b> •Continuous Door Specify Left or Right Hinge</p>	1	BCC3390	33	30	24	650
		BCC3690	36	30	24	650
 <p><b>LAZY SUSAN 90</b> •Continuous Door Specify Left or Right Hinge</p> <p>Includes 2-28" Super Susan Shelves</p>	2	LS3390	33	30	24	850
		LS3690	36	30	24	850

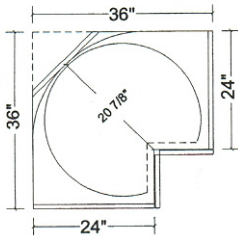

Base Corner BACC3690  
Lazy Susan LS3690

Base Corner Cabinets are available with 2 types of full height doors:

- a. 45° Corner Angles Door, hinges LEFT or RIGHT.
- b. 90° Corner Continuous Door, strap-hinged LEFT or RIGHT. The strap hinge allows the door to be flexed back slightly to clear the face of adjacent cabinet.

Case Height: 30"	Overall Height: 34-1/2"	Custom Height: Add 20%
Additional Depths	25" to 27" add 10%	Fractions Add \$125 per cabinet
	29" to 30" add 15%	Custom Items Add 30% to cabinet price
	31" to 33" add 20%	
Interior Options Black and Almond Melamine - add 10% of case		
Stock Melamine Colors - add 25% of case		
Finished Wood and other Melamine Colors - Double price of case		
Additional Melamine Shelves - MS - \$25 each		

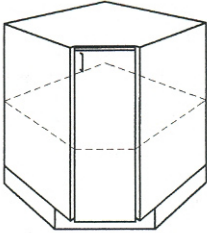
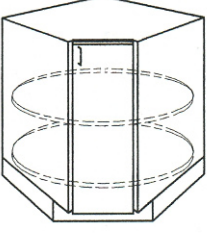
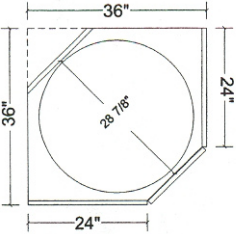
		SHELVES	CODE	W	H	D	PRICE
 <p><b>BASE CORNER 45</b> •Single Door Specify Left or Right Hinge</p>	1		BACC3345	33	30	24	550
			BACC3645	36	30	24	550
 <p><b>LAZY SUSAN 45</b> •Single Door Specify Left or Right Hinge  •Includes 2-28" Super Susan shelves Requires a Base Overlay Filler (BCOF)</p>	2		LS3345	33	30	24	750
			LS3645	36	30	24	750
 <p>Base Corner BCC3645 Lazy Susan LS3645</p> <p>Base Corner Cabinets are available with 2 types of full height doors:</p> <p>a. 45° Corner Angles Door, hinges LEFT or RIGHT.</p> <p>b. 90° Corner Continuous Door, strap-hinged LEFT or RIGHT. The strap hinge allows the door to be flexed back slightly to clear the face of adjacent cabinet.</p>		2	LSHM				475

Case Height: 30"      Overall Height: 34-1/2"      Custom Height: Add 20%

Additional Depths      25" to 27" add 10%      Fractions      Add \$125 per cabinet

                                 29" to 30" add 15%      Custom Items      Add 30% to cabinet price

                                 31" to 33" add 20%

Interior Options Black and Almond Melamine - add 10% of case  
 Stock Melamine Colors - add 25% of case  
 Finished Wood and other Melamine Colors - Double price of case

Additional Melamine Shelves - MS - \$25 each

**BASE CABINETS**

*Carriage House, Fine Kitchen Cabinetry*

**2.12**

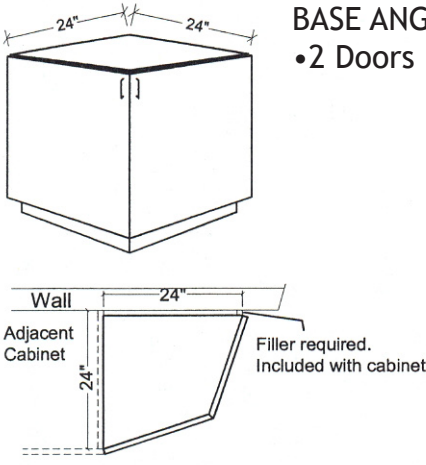
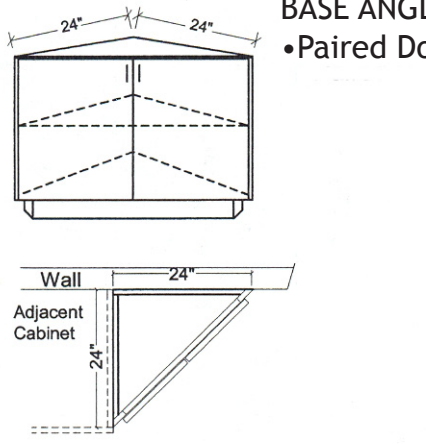
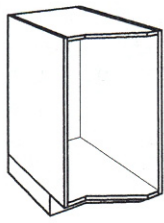
	SHELVES	CODE	W	H	D	PRICE
 <p><b>BASE ANGLE</b> • 2 Doors</p>	1	BAC2424	24	30	24	580
 <p><b>BASE ANGLE 45</b> • Paired Doors</p>	1	BA2424	24	30	24	530
 <p><b>Z Cabinet</b> • Price as base cabinet and add 130 for Z</p> <p>Add 200 to door price for Z Door</p>		ZCAB				+130  +200

Case Height: 30"  
Additional Depths

Overall Height: 34-1/2"  
25" to 27" add 10%  
29" to 30" add 15%  
31" to 33" add 20%

Custom Height: Add 20%  
Fractions Add \$125 per cabinet  
Custom Items Add 30% to cabinet price

Interior Options Black and Almond Melamine - add 10% of case  
Stock Melamine Colors - add 25% of case  
Finished Wood and other Melamine Colors - Double price of case  
Additional Melamine Shelves - MS - \$25 each

**BASE CABINETS**

*Carriage House, Fine Kitchen Cabinetry*

**2.13**

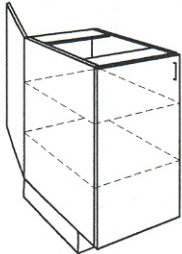
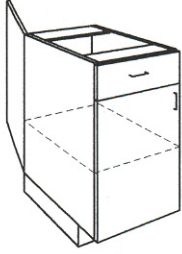
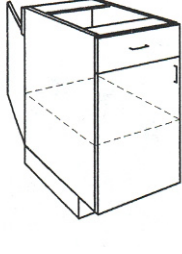
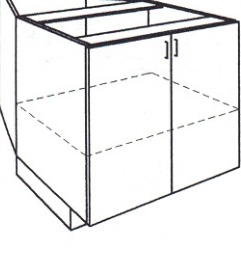
		SHELVES	CODE	W	H	D	PRICE
 <p><b>BASE DOUBLE ENTRY</b>                      •Full Height Single Doors                      Both Sides                      Specify Left or Right Hinge</p>	2	BDE12	12	30	24	320	
		BDE18	18	30	24	340	
		BDE24	24	30	24	380	
 <p><b>BASE DOUBLE ENTRY</b>                      Front Side                      •One Door &amp; One Drawer                      Back Side                      •Single Full Height Door                      Specify Left or Right Hinge</p>	2	B1DE12	12	30	24	420	
		B1DE18	18	30	24	445	
		B1DE24	24	30	24	470	
 <p><b>BASE DOUBLE ENTRY</b>                      Front Side                      •One Door &amp; One Drawer                      Back Side                      •One Door &amp; False Front                      Specify Left or Right Hinge</p>	2	B1DEF12	12	30	24	440	
		B1DEF18	18	30	24	465	
		B1DEF24	24	30	24	490	
 <p><b>BASE DOUBLE ENTRY</b>                      Both Sides                      •Full Height Paired Doors</p>	2	BDE24	24	30	24	400	
		BDE30	30	30	24	425	
		BDE36	36	30	24	450	
		BDE42	42	30	24	470	
		BDE48	48	30	24	490	

Case Height: 30"  
 Additional Depths

Overall Height: 34-1/2"  
 25" to 27" add 10%  
 29" to 30" add 15%  
 31" to 33" add 20%

Custom Height: Add 20%  
 Fractions Add \$125 per cabinet  
 Custom Items Add 30% to cabinet price

Interior Options Black and Almond Melamine - add 10% of case  
 Stock Melamine Colors - add 25% of case  
 Finished Wood and other Melamine Colors - Double price of case  
 Additional Melamine Shelves - MS - \$25 each

**BASE CABINETS**

*Carriage House, Fine Kitchen Cabinetry*

**2.14**

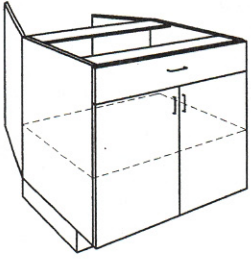
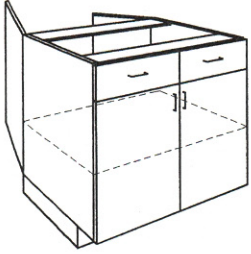
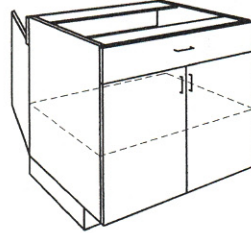
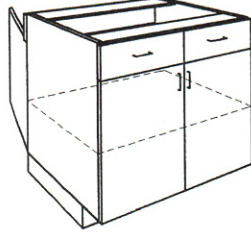
		SHELVES	CODE	W	H	D	PRICE
 <p><b>BASE DOUBLE ENTRY</b> Front Side •Paired Doors &amp; 1 Drawer Back Side •Full Height Paired Doors</p>	1		B1DE24	24	30	24	510
			B1DE30	30	30	24	530
			B1DE36	36	30	24	555
 <p><b>BASE DOUBLE ENTRY</b> Front Side •Paired Doors &amp; 2 Drawers Back Side •Full Height Paired Doors</p>	1		B2DE24	42	30	24	655
			B2DE48	48	30	24	670
 <p><b>BASE DOUBLE ENTRY</b> Front Side •Paired Doors &amp; 1 Drawer Back Side •Paired Doors &amp; 1 False Front</p>	1		B1DEF24	24	30	24	530
			B1DEF30	30	30	24	555
			B1DEF36	36	30	24	580
 <p><b>BASE DOUBLE ENTRY</b> Front Side •Paired Doors &amp; 2 Drawers Back Side •Paired Doors &amp; 1 False Front</p>	1		B2DEF42	42	30	24	680
			B2DEF48	48	30	24	710

Case Height: 30"  
Additional Depths

Overall Height: 34-1/2"  
25" to 27" add 10%  
29" to 30" add 15%  
31" to 33" add 20%

Custom Height: Add 20%  
Fractions Add \$125 per cabinet  
Custom Items Add 30% to cabinet price

Interior Options Black and Almond Melamine - add 10% of case  
Stock Melamine Colors - add 25% of case  
Finished Wood and other Melamine Colors - Double price of case  
Additional Melamine Shelves - MS - \$25 each

**BASE CABINETS**

*Carriage House, Fine Kitchen Cabinetry*

**2.15**

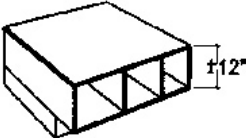
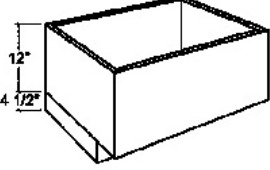
		CODE	W	H	D	PRICE
	<p><b>TV PLATFORM</b></p> <ul style="list-style-type: none"> <li>•Includes Finished Top</li> </ul> <p>Add for front Add for drawers</p>	TVPLAT	SPECIFY SIZE			75 PER SQ. FT.
		<p><b>BENCH SEAT OPEN TOP</b></p>	BENCHTOP	12	24	150 PER FT.
<p><b>BENCH RAISED PANEL FRONT</b></p> <p>Bid as base back panel (see panels section)</p>			SPECIFY SIZE			

Additional Depths      25" to 27" add 10%  
                                  29" to 30" add 15%  
                                  31" to 33" add 20%

Interior Options Black and Almond Melamine - add 10% of case  
                                  Stock Melamine Colors - add 25% of case  
                                  Finished Wood and other Melamine Colors - Double price of case

Additional Melamine Shelves - MS - \$25 each

Fractions              Add \$125 per cabinet  
 Custom Items        Add 30% to cabinet price

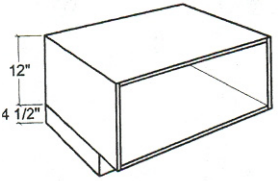
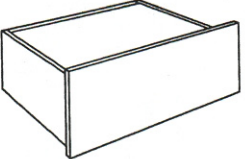
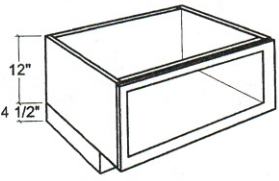
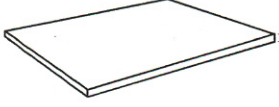
		CODE	W	H	D	PRICE
 <p><b>BENCH SEAT</b> Add for Doors</p>		BENCH	12	24		150 PER FT.
						SPECIFY SIZE
 <p><b>BENCH SEAT DRAWER</b> Add for Drawer Fronts</p>		BENCHDR				200
 <p><b>BENCH SEAT OPEN</b> Includes Wood Interior Includes 1-1/2" Face Frame</p>		BENCHOPEN	12	24		350 PER FT.
						SPECIFY SIZE
 <p><b>WOOD DECK</b> Includes Trim on 3 Sides</p>		WD				80 PER SQ. FT.
						SPECIFY SIZE

Additional Depths      25" to 27" add 10%      Fractions      Add \$125 per cabinet  
                                  29" to 30" add 15%      Custom Items      Add 30% to cabinet price  
                                  31" to 33" add 20%

Interior Options Black and Almond Melamine - add 10% of case  
 Stock Melamine Colors - add 25% of case  
 Finished Wood and other Melamine Colors - Double price of case

Additional Melamine Shelves - MS - \$25 each

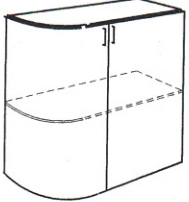
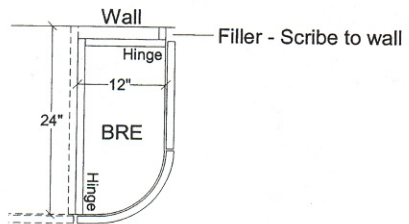
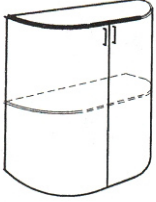
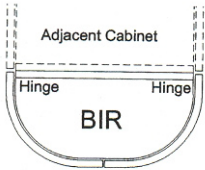

	SHELVES	CODE	W	H	D	PRICE
 <p><b>BASE RADIUS END</b>                      •1 Fixed Shelf                      •Includes Radius Door and Radius Toe Kick                      •Style Limitations</p>	1	BRE1212 BRE1224DD	24 24	30 30	12 24	850 950
		1	B2DE24 B2DE48	42 48	30 30	24 24
<p>1. One 10" radius door is hinged to the side and on flat door is hinged to the back. A filler to scribe to wall is included.                      2. Specify left or right cabinet. RIGHT cabinet shown.                      3. Custom widths, heights, or depths are available.                      4. Base Radius Ends are not available routed for glass.</p>						
 <p><b>BASE ISLAND RADIUS</b>                      •1 Fixed Shelf                      •Includes 2 Radius Doors and Radius Toe Kick                      •Style Limitations</p>	1	BIR26DD	24	30	12	1500
						
<p>1. Custom widths, heights, or depths are available.                      2. Base island Radius not available routed for glass.</p>						

Case Height: 30"      Overall Height: 34-1/2"      Custom Height: Add 20%

Additional Depths      25" to 27" add 10%      Fractions      Add \$125 per cabinet

                                 29" to 30" add 15%      Custom Items      Add 30% to cabinet price

                                 31" to 33" add 20%

Interior Options Black and Almond Melamine - add 10% of case  
 Stock Melamine Colors - add 25% of case  
 Finished Wood and other Melamine Colors - Double price of case

Additional Melamine Shelves - MS - \$25 each

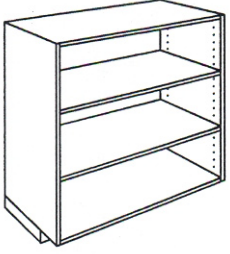
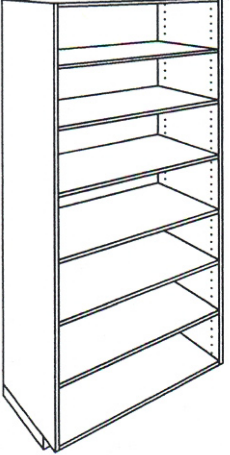
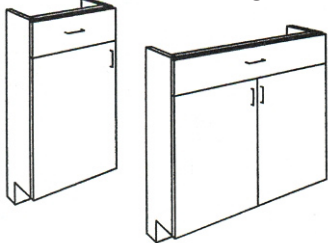
	SHELVES	CODE	W	H	D	PRICE	
 <p><b>BASE OPEN SHELF</b>                      •BOS are not available with face frames or 1½” shelves.                      •Includes wood interior                      Add for type of wood                      Add for Bead Board backs</p>	2	BOS12	12	30	12	500	
		BOS18	18	30	12	550	
		BOS24	24	30	12	600	
		BOS30	30	30	12	650	
		BOS36	36	30	12	700	
		BOS42	42	30	12	750	
		BOS48	48	30	12	800	
		BKBEAD				20 PER SQ. FT.	
 <p><b>BOOKCASE</b>                      Add for Bead Board backs</p> <p>BK 12” to 30” - 3/4” shelf with 1½” trim                      BK 31” to 48” - 1½” shelf with 1½” trim                      Face Frame included with matching edge                      BK under 6 sq. ft. price 120 per sq. ft.</p>		BK12			12	80	
		BK15			15	85	
		BK18			18	90	
		BK24			24	100	
		BK27			27	115	
		BK30			30	130	
		BKBEAD					20 PER SQ. FT.
							PER SQ. FT.
 <p><b>BASE FRONTS</b>                      Add for Doors                      Add 350 when cutting bottom shelf on site</p>		BFR				120	

Case Height: 30”  
 Additional Depths

Overall Height: 34-1/2  
 25” to 27” add 10%  
 29” to 30” add 15%  
 31” to 33” add 20%

Custom Height: Add 20%  
 Fractions Add \$125 per cabinet  
 Custom Items Add 30% to cabinet price

Interior Options Black and Almond Melamine - add 10% of case  
 Stock Melamine Colors - add 25% of case  
 Finished Wood and other Melamine Colors - Double price of case  
 Additional Melamine Shelves - MS - \$25 each

**BASE CABINETS**

*Carriage House, Fine Kitchen Cabinetry*

**2.19**

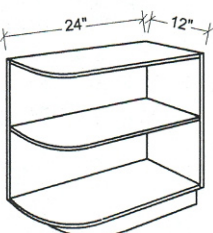
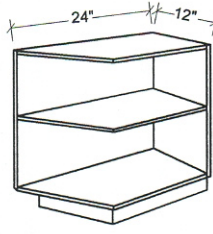
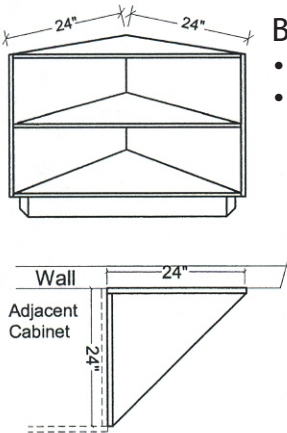
	SHELVES	CODE	W	H	D	PRICE
 <p><b>BASE RADIUS OPEN SHELF</b>                      •1 Fixed Shelf                      •Includes Wood Interior                       Add \$160 for radius toe kick</p>	1	BROS12	12	30	24	550
 <p><b>BASE ANGLED OPEN SHELF</b>                      •1 Fixed Shelf                      •Includes Wood Interior</p>	1	BAOS12	12	30	24	550
 <p><b>BASE ANGLE END SHELF</b>                      •1 Fixed Shelf                      •Includes Wood Interior</p>	1	BAES12	24	30	24	720

Case Height: 30"      Overall Height: 34-1/2"      Custom Height: Add 20%

Additional Depths      25" to 27" add 10%      Fractions      Add \$125 per cabinet

                                 29" to 30" add 15%      Custom Items      Add 30% to cabinet price

                                 31" to 33" add 20%

Interior Options Black and Almond Melamine - add 10% of case  
 Stock Melamine Colors - add 25% of case  
 Finished Wood and other Melamine Colors - Double price of case

Additional Melamine Shelves - MS - \$25 each

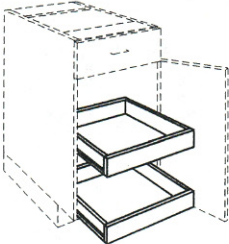
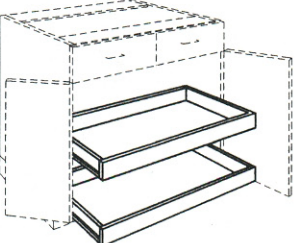
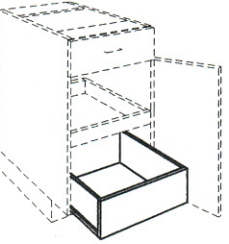
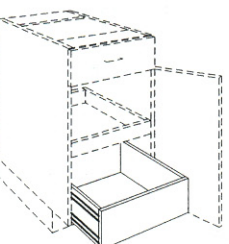
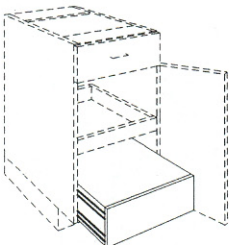
	<b>CODE</b>	<b>PRICE</b>
 <p><b>ROLL-OUT TRAY DRAWER STANDARD</b></p> <ul style="list-style-type: none"> <li>•100 lb. Capacity</li> <li>•Includes 1" Distance Blocks</li> <li>•5/8" Construction</li> <li>•Maximum width for standard ROT is 30"</li> </ul>	ROT	200
 <p><b>ROLL-OUT TRAY DRAWER OVERSIZED</b></p> <ul style="list-style-type: none"> <li>•150 lb. Capacity</li> <li>•Includes 1" Distance Blocks</li> <li>•5/8" Construction</li> <li>•Sizes 31" to 42"</li> </ul>	ROTOV	285
 <p><b>ROLL-OUT TRAY DRAWER 6"</b></p> <ul style="list-style-type: none"> <li>•Includes 1" Distance Blocks</li> <li>•6" Deep Drawer</li> </ul>	ROT6	250
 <p><b>DOUBLE SLIDE ROLL-OUT TRAY</b> Add for extra slide</p> <ul style="list-style-type: none"> <li>•Double slide system to add stability and strength</li> </ul>	ROTEXS	25
 <p><b>DOUBLE SLIDE ROLL-OUT TRAY</b> Add for flush top</p> <ul style="list-style-type: none"> <li>•Double slide system to add stability and strength</li> </ul>	ROTFT	75

	<b>CODE</b>	<b>PRICE</b>
<p><b>CUSTOM ITEMS</b>                      Not shown in book: add 30% to cabinet price</p>		30%
<p><b>MIXED COLORS IN SINGLE CABINET</b>                      When mixing more than one color on one cabinet: add 35% to cabinet price</p>		50%
<p><b>MIXED COLORS IN SINGLE CABINET</b>                      When mixing more than two colors in one room: add 75% to cabinet price of all cabinets of the 3rd, 4th, etc. color</p>		75%
<p><b>HARDWARE</b>                      When pulls are drilled on job site: add 4.00 per pull</p>		4





*Carriage House*  
*Fine Kitchen Cabinetry*







**VANITY CABINETS**

*Carriage House, Fine Kitchen Cabinetry*

**3.1**

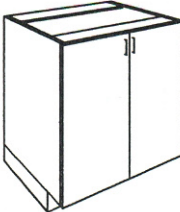
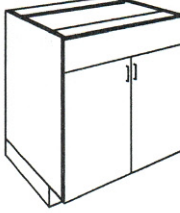
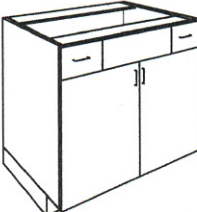
		SHELVES	CODE	W	H	D	PRICE
 <p>VANITY SINK</p> <ul style="list-style-type: none"> <li>•Single Door</li> <li>Specify Left or Right Hinge</li> <li>•No Back</li> </ul>	0	VS12	12	26	21	200	
		VS18	18	26	21	210	
		VS24	24	26	21	230	
 <p>VANITY SINK</p> <ul style="list-style-type: none"> <li>•Single Door</li> <li>Specify Left or Right Hinge</li> <li>•False Front</li> <li>•No Back</li> </ul>	0	VS1F12	12	26	21	250	
		VS1F18	18	26	21	260	
		VS1F24	24	26	21	280	
 <p>VANITY SINK</p> <ul style="list-style-type: none"> <li>•Paired Doors</li> <li>•No Back</li> </ul>	0	VS24	24	26	21	260	
		VS30	30	26	21	280	
		VS36	36	26	21	300	
		VS42	42	26	21	320	
		VS48	48	26	21	340	
 <p>VANITY SINK</p> <ul style="list-style-type: none"> <li>•Paired Doors</li> <li>•False Front</li> <li>•No Back</li> </ul>	0	VS1F24	24	26	21	310	
		VS1F30	30	26	21	330	
		VS1F36	36	26	21	350	
		VS1F42	42	26	21	370	
		VS1F48	48	26	21	390	
 <p>VANITY SINK CENTER FALSE</p> <ul style="list-style-type: none"> <li>•Paired Doors</li> <li>•2 Drawers</li> <li>•Center False Front</li> <li>•No Back</li> </ul>	0	VSDA39	39	26	21	550	
		VSDA42	42	26	21	570	
		VSDA45	45	26	21	590	
		VSDA48	48	26	21	610	

Case Height: 26"  
Additional Depths

Overall Height: 30-1/2"  
22" to 27" add 10%  
28" to 30" add 15%  
31" to 33" add 20%

Custom Height: Add 20%  
Fractions Add \$125 per cabinet  
Custom Items Add 30% to cabinet price

Interior Options Black and Almond Melamine - add 10% of case  
Stock Melamine Colors - add 25% of case  
Finished Wood and other Melamine Colors - Double price of case  
Additional Melamine Shelves - MS - \$25 each

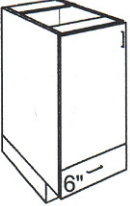
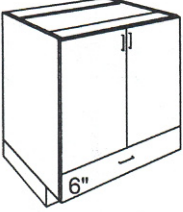
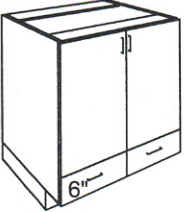
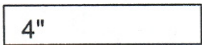
		SHELVES	CODE	W	H	D	PRICE
 <p>VANITY SINK DRAWER                      •Single Door                      Specify Left or Right Hinge                      •3 Drawers                      •False Front                      •No Back</p>	0		VSDA39	39	26	21	550
			VSDA42	42	26	21	570
			VSDA45	45	26	21	590
			VSDA48	48	26	21	610
 <p>VANITY SINK DRAWER                      •Single Door                      Specify Left or Right Hinge                      •1 Bottom Drawer                      •No Back</p>	0		VSD112	12	26	21	325
			VSD118	18	26	21	335
			VSD124	24	26	21	345
 <p>VANITY SINK DRAWER                      •Paired Doors                      •1 Bottom Drawer                      •No Back</p>	0		VSD124	24	26	21	395
			VSD130	30	26	21	415
			VSD136	36	26	21	435
 <p>VANITY SINK DRAWER                      •Paired Doors                      •2 Bottom Drawers                      •No Back</p>	0		VSD242	42	26	21	585
			VSD248	48	26	21	625
 <p>VANITY APRON                      •Paired Doors                      •2 Bottom Drawers                      •No Back</p>		MELAMINE WOOD/ FINISHED	VAPRONM VAPRONM				20 40

Case Height: 26"      Overall Height: 30-1/2"      Custom Height: Add 20%

Additional Depths      22" to 27" add 10%      Fractions      Add \$125 per cabinet

                                 28" to 30" add 15%      Custom Items      Add 30% to cabinet price

                                 31" to 33" add 20%

Interior Options Black and Almond Melamine - add 10% of case

                                 Stock Melamine Colors - add 25% of case

                                 Finished Wood and other Melamine Colors - Double price of case

Additional Melamine Shelves - MS - \$25 each

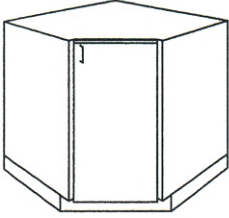
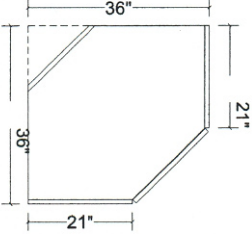
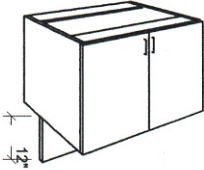
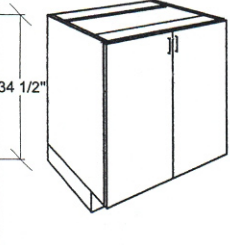
		SHELVES	CODE	W	H	D	PRICE
 <p><b>VANITY CORNER SINK 45</b></p> <ul style="list-style-type: none"> <li>• Full Height Single Door</li> <li>Specify Left or Right Hinge</li> </ul>  <p>Vanity Corner Sink Cabinet VBCS3645</p> <p>Vanity Corner Cabinets a. 45° Corner Angled Door, hinges Left or Right. b. Vanity Corner Sink Cabinets are not available with tilt-out fronts</p>	0	VCS3345 VCS3645	33 36	26 26	21 21	500 500	
	 <p><b>VANITY HUNG VANITIES</b></p> <ul style="list-style-type: none"> <li>• Includes Harwood Nailer</li> </ul> <p>(Toe Kick Support is required for granite tops)</p>						PRICE AS REGULAR VANITY
 <p><b>VANITY TALL</b></p> <ul style="list-style-type: none"> <li>• Identify cabinets by adding a "T"</li> </ul>		VST VST1 VBT VBTD3				PRICE AS REGULAR BASE CAB	

Case Height: 26"      Overall Height: 30-1/2"      Custom Height: Add 20%

Additional Depths      22" to 27" add 10%      Fractions      Add \$125 per cabinet

                                 28" to 30" add 15%      Custom Items      Add 30% to cabinet price

                                 31" to 33" add 20%

Interior Options Black and Almond Melamine - add 10% of case

                                 Stock Melamine Colors - add 25% of case

                                 Finished Wood and other Melamine Colors - Double price of case

Additional Melamine Shelves - MS - \$25 each

**VANITY CABINETS**

*Carriage House, Fine Kitchen Cabinetry*

**3.4**

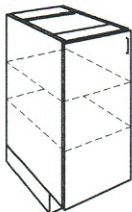
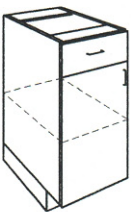
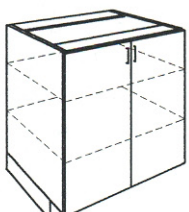
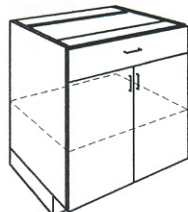
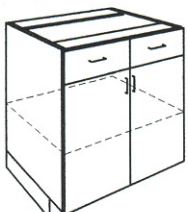
		SHELVES	CODE	W	H	D	PRICE
 <p>VANITY BASE</p> <ul style="list-style-type: none"> <li>•Single Door</li> <li>Specify Left or Right Hinge</li> </ul>	2	VB12	12	26	21	230	
		VB18	18	26	21	245	
		VB24	24	26	21	260	
 <p>VANITY BASE</p> <ul style="list-style-type: none"> <li>•Single Door</li> <li>Specify Left or Right Hinge</li> <li>•1 Drawer</li> <li>Add \$150 for extra drawer</li> </ul>	1	VB112	12	26	21	300	
		VB118	18	26	21	310	
		VB124	24	26	21	330	
			DRAWER				150
 <p>VANITY BASE</p> <ul style="list-style-type: none"> <li>•Paired Doors</li> </ul>	2	VB24	24	26	21	300	
		VB30	30	26	21	330	
		VB36	36	26	21	350	
		VB42	42	26	21	370	
 <p>VANITY BASE</p> <ul style="list-style-type: none"> <li>•Paired Doors</li> <li>•1 Drawer</li> <li>Add \$150 for extra drawer</li> </ul>	1	VB124	24	26	21	310	
		VB130	30	26	21	330	
		VB136	36	26	21	350	
				DRAWER			
 <p>VANITY BASE</p> <ul style="list-style-type: none"> <li>•Paired Doors</li> <li>•2 Drawers</li> </ul>	1	VB230	30	26	21	550	
		VB236	36	26	21	570	
		VB242	42	26	21	590	
				DRAWER			

Case Height: 26"  
Additional Depths

Overall Height: 30-1/2"  
22" to 27" add 10%  
28" to 30" add 15%  
31" to 33" add 20%

Custom Height: Add 20%  
Fractions Add \$125 per cabinet  
Custom Items Add 30% to cabinet price

Interior Options Black and Almond Melamine - add 10% of case  
Stock Melamine Colors - add 25% of case  
Finished Wood and other Melamine Colors - Double price of case  
Additional Melamine Shelves - MS - \$25 each

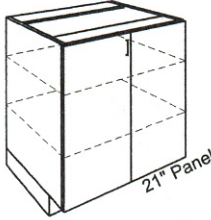
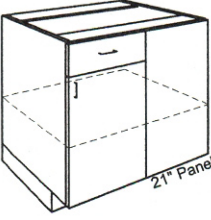
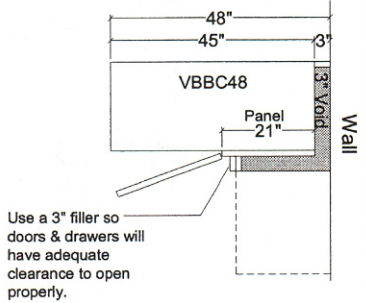
	SHELVES	CODE	W	H	D	PRICE
 <p>VANITY BASE BLIND CORNER Specify Left or Right Left Illustrated •1 Door •21" Panel</p> <p>Requires a Base Overlay Filler (BCOF)</p>	2	VBBC39	39	26	21	470
		VBBC42	42	26	21	480
		VBBC45	45	26	21	490
		VBBC48	48	26	21	500
 <p>VANITY BASE BLIND CORNER Specify Left or Right Left Illustrated •1 Door •1 Drawer •21" Panel</p> <p>Requires a Base Overlay Filler (BCOF)</p>	2	VBBC139	39	26	21	530
		VBBC142	42	26	21	540
		VBBC145	45	26	21	550
		VBBC148	48	26	21	560
 <p>Use a 3" filler so doors &amp; drawers will have adequate clearance to open properly.</p>						

Case Height: 26"  
Additional Depths

Overall Height: 30-1/2"  
22" to 27" add 10%  
28" to 30" add 15%  
31" to 33" add 20%

Custom Height: Add 20%  
Fractions Add \$125 per cabinet  
Custom Items Add 30% to cabinet price

Interior Options Black and Almond Melamine - add 10% of case  
Stock Melamine Colors - add 25% of case  
Finished Wood and other Melamine Colors - Double price of case  
Additional Melamine Shelves - MS - \$25 each

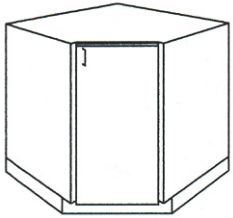
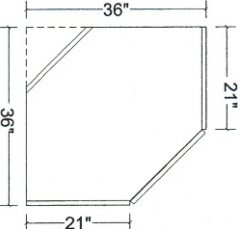
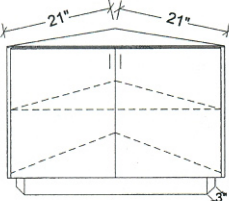
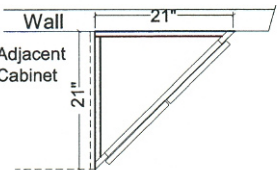
	SHELVES	CODE	W	H	D	PRICE
 <p>VANITY BASE CORNER 45</p> <ul style="list-style-type: none"> <li>• Full Height Single Door</li> <li>Specify Left or Right Hinge</li> </ul>  <p>Vanity Corner Cabinet VBC3645</p>	1	VBC3345 VBC3645	33 36	26 26	21 21	560 560
 <p>VANITY BASE ANGLE 45</p> <ul style="list-style-type: none"> <li>• Paired Doors</li> </ul>  <p>Wall Adjacent Cabinet 21"</p>	1	VBA2121	21	26	21	380

Case Height: 26"  
Additional Depths

Overall Height: 30-1/2"  
22" to 27" add 10%  
28" to 30" add 15%  
31" to 33" add 20%

Interior Options Black and Almond Melamine - add 10% of case  
Stock Melamine Colors - add 25% of case  
Finished Wood and other Melamine Colors - Double price of case

Additional Melamine Shelves - MS - \$25 each

Custom Height: Add 20%  
Fractions Add \$125 per cabinet  
Custom Items Add 30% to cabinet price

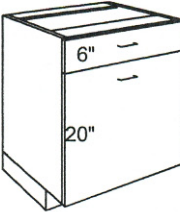
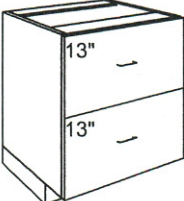
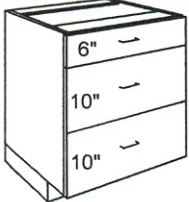
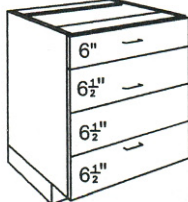
	DRAWERS	CODE	W	H	D	PRICE
 <p><b>VANITY BASE PULL OUT</b>                      • 2 Drawers                      • Designed for Pull-Out Trash                      Add \$100 for full sides on bottom drawer</p>	2	VBPO12D2	12	26	21	540
		VBPO18D2	18	26	21	560
		VBPO24D2	24	26	21	580
 <p><b>VANITY BASE FILE</b>                      • 2 File drawers                      • Includes File Racks                      • Includes Full Extension Glides                      16" wide minimum for letter                      20" wide minimum for legal</p>	2	VF16D2	16	26	21	540
		VF20D2	20	26	21	560
		VF24D2	24	26	21	580
		VF27D2	27	26	21	600
		VF30D2	30	26	21	620
		VF33D2	33	26	21	640
		VF36D2	36	26	21	680
		VF42D2	42	26	21	710
	DRAWER					150
 <p><b>VANITY BASE DRAWER</b>                      • 3 Drawers                      Drawers over 36" will have Heavy Duty Full Extension Glides</p>	3	VB12D3	12	26	21	480
		VB18D3	18	26	21	500
		VB24D3	24	26	21	530
		VB30D3	30	26	21	590
		VB36D3	36	26	21	620
		VB37D3	37	26	21	770
		VB42D3	42	26	21	790
	INCLUDES FEG					
 <p><b>VANITY BASE DRAWER</b>                      • 4 Drawers                      Drawers over 36" will have Heavy Duty Full Extension Glides</p>	4	VB12D4	12	26	21	570
		VB18D4	18	26	21	590
		VB24D4	24	26	21	635
		VB30D4	30	26	21	660
		VB36D4	36	26	21	690
		VB37D4	37	26	21	890
		VB42D4	42	26	21	910
	INCLUDES					

Case Height: 26"  
 Additional Depths

Overall Height: 30-1/2"  
 22" to 27" add 10%  
 28" to 30" add 15%  
 31" to 33" add 20%

Custom Height: Add 20%  
 Fractions Add \$125 per cabinet  
 Custom Items Add 30% to cabinet price

Interior Options Black and Almond Melamine - add 10% of case  
 Stock Melamine Colors - add 25% of case  
 Finished Wood and other Melamine Colors - Double price of case  
 Additional Melamine Shelves - MS - \$25 each

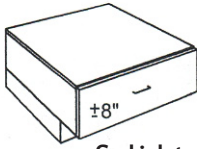
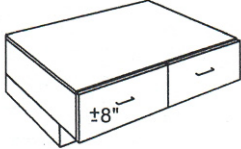
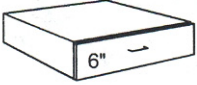
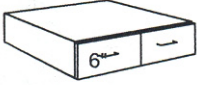
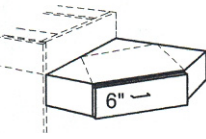
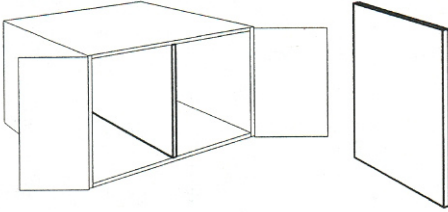
	DRAWERS	CODE	W	H	D	PRICE
 <p><b>VANITY BASE PEDESTAL</b>                      •1 Drawer                      •Variable Height                      Solid top extends to outer edges</p>	1	VBP24D1	24		21	250
		VBP30D1	30		21	270
 <p><b>VANITY BASE PEDESTAL</b>                      •2 Drawers                      •Variable Height                      Solid top extends to outer edges</p>	1	VBP36D2	36		21	430
		VBP42D2	42		21	450
		VBP48D2	48		21	470
 <p><b>VANITY DRAWER SUSPENDED</b>                      •Suspended Drawer Single</p>	1	VD124	24	6	21	230
		VD130	30	6	21	250
		VD136	36	6	21	270
 <p><b>VANITY DRAWER SUSPENDED</b>                      •Suspended Drawer Double</p>	2	VD236	36	6	21	420
		VD242	42	6	21	450
		VD248	48	6	21	480
 <p><b>VANITY ANGLE DRAWER SUSPENDED</b>                      •Suspended Corner</p>	1	VSDA12121	21	6	21	300
		VSDA12424	24	6	24	330
<p><b>DIVIDER VANITY BASE</b></p> 		DIVV				100

Case Height: 26"      Overall Height: 30-1/2"      Custom Height: Add 20%

Additional Depths      22" to 27" add 10%      Fractions      Add \$125 per cabinet

                                 28" to 30" add 15%      Custom Items      Add 30% to cabinet price

                                 31" to 33" add 20%

Interior Options Black and Almond Melamine - add 10% of case

                                 Stock Melamine Colors - add 25% of case

                                 Finished Wood and other Melamine Colors - Double price of case

Additional Melamine Shelves - MS - \$25 each

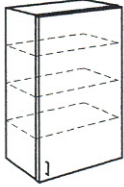
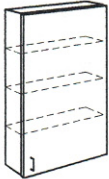
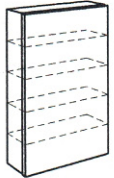
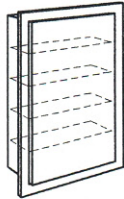
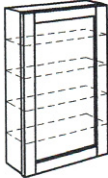

		DRAWERS	CODE	W	H	D	PRICE
 <p>8" Deep</p>	<p><b>JOHN CABINET</b>                      •1 Door                      Specify Left or Right Hinge</p>	3	VJC2430	24	30	8	325
			VJC2730	27	30	8	335
			VJC3030	30	30	8	345
 <p>4" Deep</p>	<p><b>MEDICINE CABINET</b>                      •1 Door                      Specify Left or Right Hinge</p>	3	VMC2430	24	30	4	300
			VMC2730	27	30	4	320
			VMC3030	30	30	4	340
 <p>Plain Door 4" Deep</p>	<p><b>MEDICINE CABINET</b>                      •Single Plain Door for Mirror                      Specify Left or Right Hinge                      •Finished all sides                      •1/4" Glass Shelves                        • Mirror not included</p>	4	VMCP2130	21	30	4	500
			VMCP2430	24	30	4	520
 <p>Plain Door Face Frame 4" Deep</p>	<p><b>MEDICINE CABINET</b>                      •Single Plain Door for Mirror                      Specify Left or Right Hinge                      •Finished all sides                      •1/4" Glass Shelves                        • Mirror not included</p>	4	VMCFF2130	21	30	4	550
			VMCFF2430	24	30	4	570
 <p>Framed Door 4" Deep</p>	<p><b>MEDICINE CABINET</b>                      •Single Framed Door                      for Mirror                      Specify Left or Right Hinge                      •Finished all sides                      •1/4" Glass Shelves                        • Mirror not included</p>	4	VMCF2130	21	30	4	550
			VMCF2430	24	30	4	570

Case Height: 26"      Overall Height: 30-1/2"      Custom Height: Add 20%

Additional Depths      22" to 27" add 10%      Fractions      Add \$125 per cabinet

                                 28" to 30" add 15%      Custom Items      Add 30% to cabinet price

                                 31" to 33" add 20%

Interior Options Black and Almond Melamine - add 10% of case  
 Stock Melamine Colors - add 25% of case  
 Finished Wood and other Melamine Colors - Double price of case

Additional Melamine Shelves - MS - \$25 each

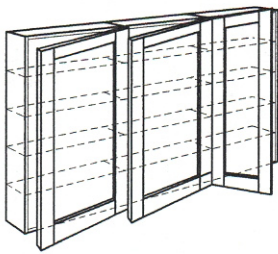
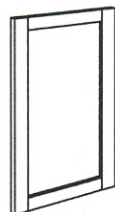
	SHELVES	CODE	W	H	D	PRICE
 <p><b>MEDICINE CABINET</b>  <ul style="list-style-type: none"> <li>•SINGLE DOOR</li> <li>Specify Left or Right Hinge</li> <li>•Finished Sides</li> <li>•1/4" Glass Shelves</li> </ul> </p> <p>Three units shown to form a tri-mirror application</p> <ul style="list-style-type: none"> <li>•Add for Doors</li> <li>•4" deep</li> <li>•Mirror not included</li> </ul>						PRICE AS VCMP OR VMCF
 <p><b>MIRROR FRAME</b>  <ul style="list-style-type: none"> <li>•Mirror not included</li> </ul> </p>		MIRF				18 PER SQ. FT.
<p><b>MIRROR</b></p> <ul style="list-style-type: none"> <li>•1/8" or 1/4" Polished edges extra</li> </ul> <p>If mirror is damaged it will be deducted from NO FAULT</p>		MIRROR				25 PER SQ. FT.
<p>Case Height: 26"      Overall Height: 30-1/2"      Custom Height: Add 20%</p> <p>Additional Depths      22" to 27" add 10%      Fractions      Add \$125 per cabinet</p> <p>                                 28" to 30" add 15%      Custom Items      Add 30% to cabinet price</p> <p>                                 31" to 33" add 20%</p> <p>Interior Options Black and Almond Melamine - add 10% of case</p> <p>                                 Stock Melamine Colors - add 25% of case</p> <p>                                 Finished Wood and other Melamine Colors - Double price of case</p> <p>Additional Melamine Shelves - MS - \$25 each</p>						

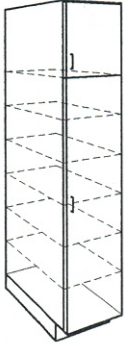
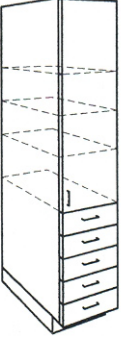
		SHELVES	CODE	W	H	D	PRICE
 <p><b>VANITY LINEN</b></p> <ul style="list-style-type: none"> <li>•2 Doors</li> <li>Specify Type A, B, or C.</li> <li>Specify Left or Right Hinge</li> <li>•Includes One Fixed Shelf</li> </ul>	6		VLCA1284	12	84	21	780
			VLCA1884	18	84	21	800
			VLCA2484	24	84	21	830
			VLCA1296	12	96	21	860
			VLCA1896	18	96	21	890
			VLCA2496	24	96	21	910
 <p><b>VANITY LINEN DRAWER</b></p> <ul style="list-style-type: none"> <li>•1 Door</li> <li>Specify Left or Right Hinge</li> <li>•Includes One Fixed Shelf</li> <li>•Drawers</li> </ul> <p>Drawer Sizes:                      Vanity 3 Drawers                      Base 4 Drawers                      Base 5 Drawers</p>	3 DRAWER		VLD31284	12	84	21	1030
			VLD31884	18	84	21	1070
			VLD32484	24	84	21	1130
			VLD31296	12	96	21	1200
			VLD31896	18	96	21	1250
			VLD32496	24	96	21	1310
			4 DRAWER	VLD41284	12	84	21
			VLD41884	18	84	21	1220
			VLD42484	24	84	21	1280
			VLD41296	12	96	21	1350
			VLD41896	18	96	21	1400
			VLD42496	24	96	21	1460
			5 DRAWER	VLD51284	12	84	21
			VLD51884	18	84	21	1370
			VLD52484	24	84	21	1430
			VLD51296	12	96	21	1500
			VLD51896	18	96	21	1550
			VLD52496	24	96	21	1610

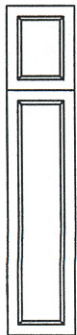

Type "A"

Note: Make note if doors are to line up with other doors

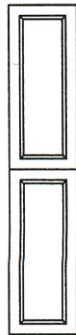

Type "B"

Note: "B" cabinets have equal doors

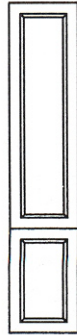

Type "C"

Note: Lower doors line up with base cabinets

Case Height: 26"  
Additional Depths

Overall Height: 30-1/2"  
22" to 27" add 10%  
28" to 30" add 15%  
31" to 33" add 20%

Custom Height: Add 20%  
Fractions Add \$125 per cabinet  
Custom Items Add 30% to cabinet price

Interior Options Black and Almond Melamine - add 10% of case  
 Stock Melamine Colors - add 25% of case  
 Finished Wood and other Melamine Colors - Double price of case  
 Additional Melamine Shelves - MS - \$25 each

	<b>CODE</b>	<b>PRICE</b>
<p><b>CUSTOM ITEMS</b> Not shown in book: add 30% to cabinet price</p>		30%
<p><b>MIXED COLORS IN SINGLE CABINET</b> When mixing more than one color on one cabinet: add 35% to cabinet price</p>		50%
<p><b>MIXED COLORS IN SINGLE CABINET</b> When mixing more than two colors in one room: add 75% to cabinet price of all cabinets of the 3rd, 4th, etc. color</p>		75%
<p><b>HARDWARE</b> When pulls are drilled on job site: add 4.00 per pull</p>		4



*Carriage House*  
*Fine Kitchen Cabinetry*



**DESK CABINETS**

*Carriage House, Fine Kitchen Cabinetry*

**4.1**

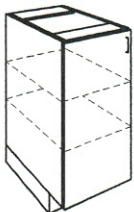
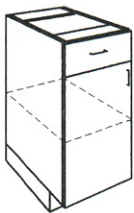
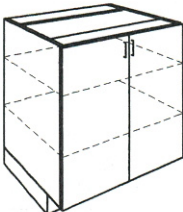
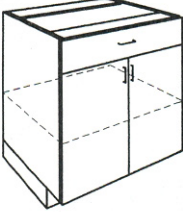
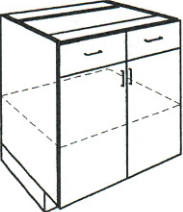
		SHELVES	CODE	W	H	D	PRICE
 <p>DESK BASE</p> <ul style="list-style-type: none"> <li>•Single Door</li> <li>Specify Left or Right Hinge</li> </ul>	2	DB12	12	24	21	230	
		DB15	15	24	21	245	
		DB18	18	24	21	245	
		DB24	24	24	21	260	
 <p>DESK BASE</p> <ul style="list-style-type: none"> <li>•Single Door</li> <li>Specify Left or Right Hinge</li> <li>•1 Drawer</li> <li>Add \$150 for extra drawer</li> </ul>	1	DB112	12	24	21	300	
		DB118	18	24	21	310	
		DB124	24	24	21	330	
		DRAWER					150
 <p>DESK BASE</p> <ul style="list-style-type: none"> <li>•Paired Doors</li> </ul>	2	DB24	24	24	21	300	
		DB30	30	24	21	330	
		DB36	36	24	21	350	
		DB42	42	24	21	370	
 <p>DESK BASE</p> <ul style="list-style-type: none"> <li>•Paired Doors</li> <li>•1 Drawer</li> <li>Add \$150 for extra drawer</li> </ul>	1	DB124	24	24	21	375	
		DB130	30	24	21	400	
		DB136	36	24	21	425	
		DB137	37	24	21	495	
		DB142	42	24	21	520	
		INCLUDES FEG					
		DRAWER					150
 <p>DESK BASE</p> <ul style="list-style-type: none"> <li>•Paired Doors</li> <li>•2 Drawers</li> <li>Add \$150 for extra drawer</li> </ul>	1	DB230	30	24	21	550	
		DB236	36	24	21	570	
		DB242	42	24	21	590	
				DRAWER			

Case Height: 24"  
Additional Depths

Overall Height: 28-1/2"  
25" to 27" add 10%  
28" to 30" add 15%  
31" to 33" add 20%

Custom Height: Add 20%  
Fractions Add \$125 per cabinet  
Custom Items Add 30% to cabinet price

Interior Options Black and Almond Melamine - add 10% of case  
Stock Melamine Colors - add 25% of case  
Finished Wood and other Melamine Colors - Double price of case  
Additional Melamine Shelves - MS - \$25 each

**DESK CABINETS**

*Carriage House, Fine Kitchen Cabinetry*

**4.2**

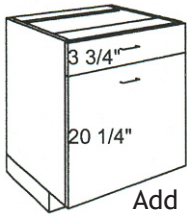
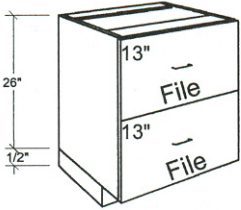
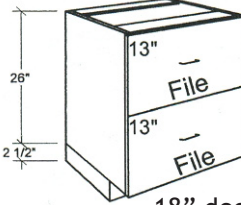
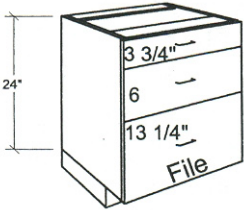
		SHELVES	CODE	W	H	D	PRICE
 <p><b>DESK PULL OUT</b></p> <ul style="list-style-type: none"> <li>•2 Drawers</li> <li>Designed for Pull-Out Trash</li> </ul> <p>Add \$100 for full sides on bottom drawer</p>	2	DPO18D2	18	24	21	550	
		DPO21D2	21	24	21	570	
		DPO24D2	27	24	21	610	
		DPO30D2	30	24	21	640	
 <p><b>DESK FILE</b></p> <ul style="list-style-type: none"> <li>•Two file drawers</li> <li>•Includes File Racks</li> <li>•Includes Full Extension Glides</li> </ul> <p>17" wide minimum for letter 20" wide minimum for legal When used with a desk a 2-1/2" toe kick is used</p>	2	DF17D2	17	26	21	540	
		DF20D2	20	26	21	560	
		DF24D2	24	26	21	580	
 <p><b>DESK FILE LATERAL</b></p> <ul style="list-style-type: none"> <li>•2 File Drawers</li> <li>•Includes File Racks</li> <li>•Includes full Extension Heavy Duty Glides</li> </ul> <p>18" deep minimum for letter 21" deep minimum for legal When used with a desk a 2-1/2" toe kick is used</p>	2	DFL16D2	16	26	21	540	
		DFL20D2	20	26	21	560	
		DFL24D2	24	26	21	580	
		DFL27D2	27	26	21	600	
		DFL30D2	30	26	21	620	
		DFL36D2	36	26	21	680	
		DFL42D2	42	26	21	720	
 <p><b>DESK FILE</b></p> <ul style="list-style-type: none"> <li>•2 Drawers</li> <li>•1 File Drawer</li> <li>•Includes File Racks</li> <li>•Includes full Extension Glides on file drawer</li> </ul> <p>17" wide minimum for letter 20" wide minimum for legal</p>	3	DF17D3	17	24	21	700	
		DF20D3	20	24	21	720	
		DF24D3	24	24	21	740	
		DF27D3	27	24	21	760	
		DF30D3	30	24	21	780	
		DF36D3	36	24	21	820	
		DF42D3	42	24	21	840	

Case Height: 24"  
Additional Depths

Overall Height: 28-1/2  
25" to 27" add 10%  
28" to 30" add 15%  
31" to 33" add 20%

Custom Height: Add 20%  
Fractions Add \$125 per cabinet  
Custom Items Add 30% to cabinet price



Interior Options Black and Almond Melamine - add 10% of case  
Stock Melamine Colors - add 25% of case  
Finished Wood and other Melamine Colors - Double price of case  
Additional Melamine Shelves - MS - \$25 each



**DESK CABINETS**

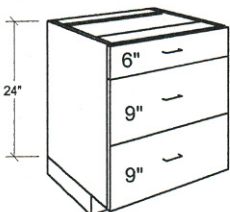
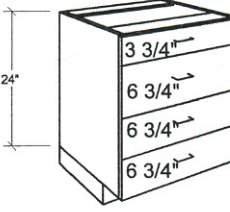

*Carriage House, Fine Kitchen Cabinetry*

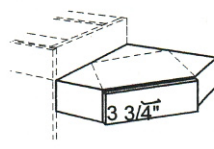
**4.3**

		SHELVES	CODE	W	H	D	PRICE	
 <p>DESK DRAWER •3 Drawers*</p>	3	DB12D3 DB18D3 DB24D3 DB36D3	12 18 24 36	24 24 24 24	21 21 21 21	480 500 530 590		
	INCLUDES FEG	DB37D3 DB42D3	37 42	24 24	21 21	690 710		
	 <p>DESK DRAWER •4 Drawers* 16" wide minimum for letter 20" deep minimum for legal</p>	4	DB12D4 DB18D4 DB24D4 DB30D4 DB36D4	12 18 24 30 36	24 24 24 24 24	21 21 21 21 21	620 650 670 720 770	
		INCLUDES FEG	DB37D4 DB42D4	37 42	24 24	21 21	970 990	
		 <p>DESK PENCIL DRAWER •Suspended Drawer Single</p>	1	DPD124 DPD130 DPD136	24 30 36	3 3/4 3 3/4 3 3/4	21 21 21	230 250 270
			 <p>DESK PENCIL DRAWER •Suspended Drawer Double</p>	2	DPD236 DPD242	35 42	3 3/4 3 3/4	21 21
 <p>DESK PENCIL DRAWER ANGLED SUSPENDED •Suspended Corner</p>				1	DPDA12121 DPDA12424	21 24	3 3/4 3 3/4	21 24

\*Drawers over 36" will have Heavy Duty Full-extension Glides

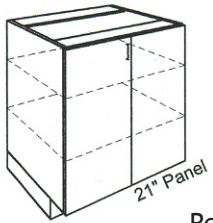
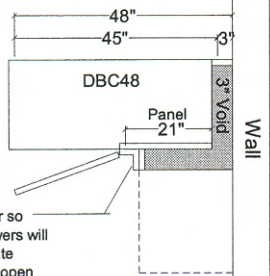
Case Height: 24"	Overall Height: 28-1/2	Custom Height: Add 20%
Additional Depths	25" to 27" add 10%	Fractions Add \$125 per cabinet
	28" to 30" add 15%	Custom Items Add 30% to cabinet price
	31" to 33" add 20%	
Interior Options Black and Almond Melamine - add 10% of case		
Stock Melamine Colors - add 25% of case		
Finished Wood and other Melamine Colors - Double price of case		
Additional Melamine Shelves - MS - \$25 each		

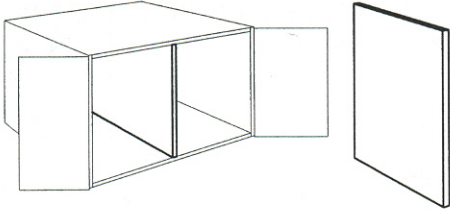
	SHELVES	CODE	W	H	D	PRICE
 <p><b>DESK BASE BLIND CORNER</b></p> <ul style="list-style-type: none"> <li>•Single Door</li> <li>Specify Left or Right Hinge</li> <li>•21" Panel</li> </ul> <p>Requires a Base Overlay Filler (BCOF)</p>  <p>Use a 3" filler so doors &amp; drawers will have adequate clearance to open properly.</p>	2	DBC39 DBC42 DBC45 DBC48	39 42 45 48	24 24 24 24	21 21 21 21	490 560 570 580
 <p><b>DESK OPEN SHELF</b></p> <ul style="list-style-type: none"> <li>•DOS are not available with face frames or 1-1/2" shelves.</li> <li>•Includes Wood Interior</li> <li>•Add for type of wood</li> </ul>	2	DOS18 DOS24 DOS30 DOS36	18 24 30 36	24 24 24 24	12 12 12 12	550 600 650 700
<p><b>DIVIDER DESK BASE</b></p> 		DIVD				100

Case Height: 24"  
Additional Depths

Overall Height: 28-1/2"  
25" to 27" add 10%  
28" to 30" add 15%  
31" to 33" add 20%

Custom Height: Add 20%  
Fractions Add \$125 per cabinet  
Custom Items Add 30% to cabinet price

Interior Options Black and Almond Melamine - add 10% of case  
Stock Melamine Colors - add 25% of case  
Finished Wood and other Melamine Colors - Double price of case  
Additional Melamine Shelves - MS - \$25 each

	<b>CODE</b>	<b>PRICE</b>
<b>CUSTOM ITEMS</b> Not shown in book: add 30% to cabinet price		30%
<b>MIXED COLORS IN SINGLE CABINET</b> When mixing more than one color on one cabinet: add 35% to cabinet price		50%
<b>MIXED COLORS IN SINGLE CABINET</b> When mixing more than two colors in one room: add 75% to cabinet price of all cabinets of the 3rd, 4th, etc. color		75%
<b>HARDWARE</b> When pulls are drilled on job site: add 4.00 per pull		4



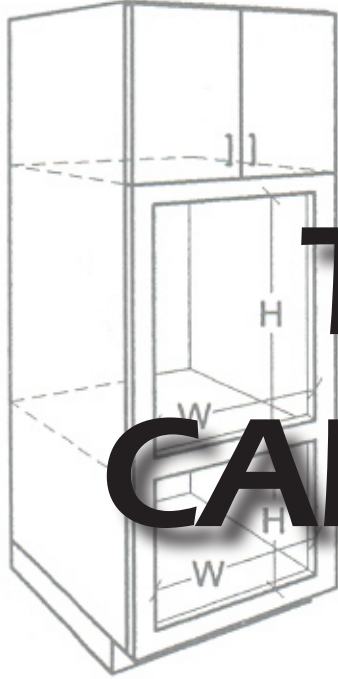

# TALL CABINETS





*Carriage House*  
*Fine Kitchen Cabinetry*



**TALL CABINETS**

*Carriage House, Fine Kitchen Cabinetry*

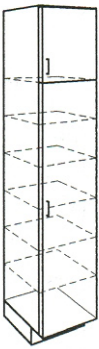
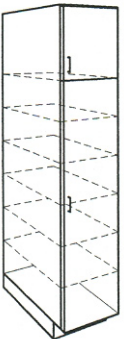
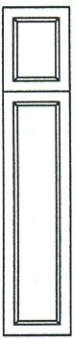
**5.1**

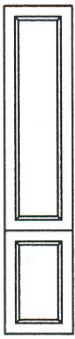
		SHELVES	CODE	W	H	D	PRICE
 <p><b>TALL PANTRY</b></p> <ul style="list-style-type: none"> <li>•12" Deep</li> <li>•2 Doors - Specify A, B, or C</li> <li>Specify Left or Right Hinge</li> <li>•Includes One Fixed Shelf</li> </ul>	6	TPSA128412	12	84	12	730	
		TPSA188412	18	84	12	750	
		TPSA248412	24	84	12	780	
		TPSA129612	12	96	12	810	
		TPSA189612	18	96	12	840	
		TPSA249612	24	96	12	860	
 <p><b>TALL PANTRY</b></p> <ul style="list-style-type: none"> <li>•24" Deep</li> <li>•2 Doors - Specify A, B, or C</li> <li>Specify Left or Right Hinge</li> <li>•Includes One Fixed Shelf</li> </ul> <p>Add for extra divider</p>	6	TPSA1284	12	84	12	930	
		TPSA1884	18	84	12	960	
		TPSA2484	24	84	12	1000	
	DRAWER	TPSA1296	12	96	12	1040	
		TPSA1896	18	96	12	1080	
		TPSA2496	24	96	12	1110	
						150	
 <p><b>TYPE "A"</b></p> <p>Note: Make note if doors are to line up with other doors.</p>	 <p><b>TYPE "B"</b></p> <p>Note: "B" cabinets have equal doors.</p>	 <p><b>TYPE "C"</b></p> <p>Note: Lower doors line up with base cabinets</p>					

Additional Depths      25" to 27" add 10%  
                                  28" to 30" add 15%  
                                  31" to 33" add 20%

Fractions              Add \$125 per cabinet  
 Custom Items        Add 30% to cabinet price

Interior Options Black and Almond Melamine - add 10% of case  
 Stock Melamine Colors - add 25% of case  
 Finished Wood and other Melamine Colors - Double price of case

Additional Melamine Shelves - MS - \$25 each

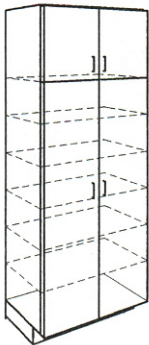
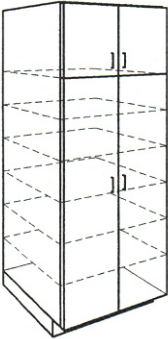
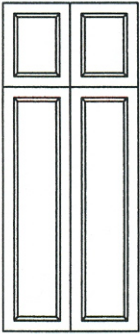
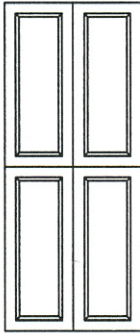
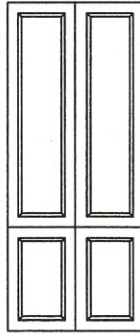
		SHELVES	CODE	W	H	D	PRICE
 <p><b>TALL PANTRY</b></p> <ul style="list-style-type: none"> <li>•12" Deep</li> <li>•4 Doors - Specify A, B, or C</li> <li>•Includes One Fixed Shelf</li> </ul> <p>Add for extra divider</p>	6	TPSA248412	24	84	12	830	
		TPSA308412	30	84	12	860	
		TPSA368412	36	84	12	900	
		TPSA428412	42	84	12	1080	
		TPSA249612	24	96	12	940	
		TPSA309612	30	96	12	980	
		TPSA369612	36	96	12	1010	
		TPSA429612	42	96	12	1180	
	DIVT					200	
 <p><b>TALL PANTRY</b></p> <ul style="list-style-type: none"> <li>•24" Deep</li> <li>•- Specify A, B, or C</li> <li>•Includes One Fixed Shelf</li> </ul> <p>Add for extra divider Add a Drawer</p>	6	TPSA2484	24	84	12	930	
		TPSA3084	30	84	12	960	
		TPSA3684	36	84	12	1000	
		TPSA4284	42	84	12	1180	
		TPSA2496	24	96	12	1040	
		TPSA3096	30	96	12	1080	
		TPSA3696	36	96	12	1110	
		TPSA4296	42	96	12	1280	
	DIVT DRAWER					200 150	
 <p>TYPE "A"</p> <p>Note: Make note if doors are to line up with other doors.</p>	 <p>TYPE "B"</p> <p>Note: "B" cabinets have equal doors.</p>	 <p>TYPE "C"</p> <p>Note: Lower doors line up with base cabinets</p>					

Additional Depths      25" to 27" add 10%  
                                  28" to 30" add 15%  
                                  31" to 33" add 20%

Fractions              Add \$125 per cabinet  
 Custom Items        Add 30% to cabinet price

Interior Options Black and Almond Melamine - add 10% of case  
 Stock Melamine Colors - add 25% of case  
 Finished Wood and other Melamine Colors - Double price of case

Additional Melamine Shelves - MS - \$25 each

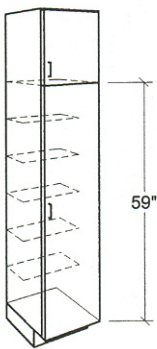
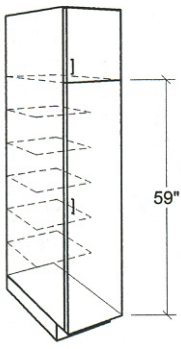
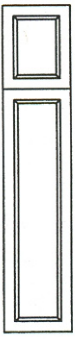

		SHELVES	CODE	W	H	D	PRICE
 <p>TALL PANTRY                      •12" Deep                      •2 Doors - Type "A"                      Specify Left or Right Hinge                      •Includes 1 fixed shelf                      •Adjustable shelves 4" deep                      •Lower door is approximately 59" high</p>	6	TBRS128412	12	84	12	630	
		TBRS188412	18	84	12	650	
		TBRS248412	24	84	12	680	
		TBRS129612	12	96	12	810	
		TBRS189612	18	96	12	840	
		TBRS249612	24	96	12	860	
 <p>TALL PANTRY                      •24" Deep                      •2 Doors - Type "A"                      Specify Left or Right Hinge                      •Includes One Fixed Shelf                      •Adjustable shelves 9" deep                      •Lower Door is Approximately 59" high</p>	6	TBRS1284	12	84	24	680	
		TBRS1884	18	84	24	700	
		TBRS2484	24	84	24	730	
		TBRS1296	12	96	24	860	
		TBRS1896	18	96	24	890	
		TBRS2496	24	96	24	910	
 <p>TYPE "A"</p> <p>Note: Make note if doors are to line up with other doors.</p>							

Additional Depths      25" to 27" add 10%      Fractions      Add \$125 per cabinet  
 28" to 30" add 15%      Custom Items      Add 30% to cabinet price  
 31" to 33" add 20%

Interior Options Black and Almond Melamine - add 10% of case  
 Stock Melamine Colors - add 25% of case  
 Finished Wood and other Melamine Colors - Double price of case

Additional Melamine Shelves - MS - \$25 each

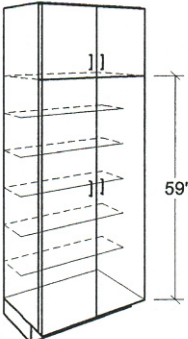
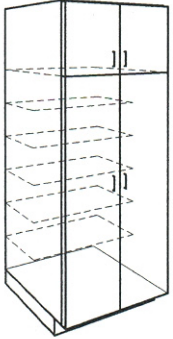
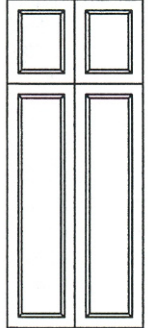
		SHELVES	CODE	W	H	D	PRICE
 <p><b>TALL PANTRY</b>                      •12" Deep                      •4 Doors - Type "A"                      •Includes 1 fixed shelf                      •Adjustable shelves 4" deep                      •Lower doors are approximately 59" high</p> <p>Add for extra divider</p>	6	TBRS248412	24	84	12	830	
		TBRS308412	30	84	12	860	
		TBRS368412	36	84	12	900	
		TBRS249612	24	96	12	940	
		TBRS309612	30	96	12	980	
		TBRS369612	36	96	12	1010	
		DIVT					200
 <p><b>TALL PANTRY</b>                      •24" Deep                      •4 Doors - Type "A"                      •Includes One Fixed Shelf                      •Adjustable shelves 9" deep                      •Lower doors are approximately 59" high</p> <p>Add for extra divider</p>	6	TBRS2484	24	84	12	930	
		TBRS3084	30	84	12	960	
		TBRS3684	36	84	12	1000	
		TBRS2496	24	96	12	1040	
		TBRS3096	30	96	12	1080	
		TBRS3696	36	96	12	1110	
		DIVT					200
 <p><b>TYPE "A"</b></p> <p>Note: Make note if doors are to line up with other doors.</p>							
<p>Additional Depths      25" to 27" add 10%                      28" to 30" add 15%                      31" to 33" add 20%</p> <p>Interior Options Black and Almond Melamine - add 10% of case                      Stock Melamine Colors - add 25% of case                      Finished Wood and other Melamine Colors - Double price of case</p> <p>Additional Melamine Shelves - MS - \$25 each</p>		<p>Fractions      Add \$125 per cabinet                      Custom Items      Add 30% to cabinet price</p>					

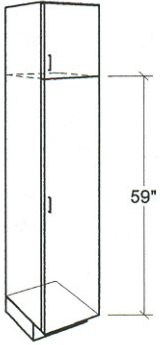
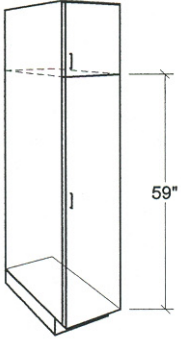
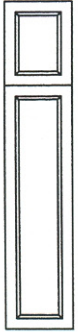
	SHELVES	CODE	W	H	D	PRICE
 <p>LOCKERS/TALL UTILITY</p> <ul style="list-style-type: none"> <li>•12" Deep</li> <li>•2 Doors - Type "A"</li> </ul> <p>Specify Left or Right Hinge</p> <ul style="list-style-type: none"> <li>•Includes 1 fixed shelf</li> <li>• No Adjustable shelves</li> <li>•Lower door is approximately 59" high</li> </ul> <p>Coat Hooks Melamine Adjustable shelf</p>	6	TUSA128412	12	84	12	600
		TUSA188412	18	84	12	650
		TUSA248412	24	84	12	670
		TUSA129612	12	96	12	650
		TUSA189612	18	96	12	680
		TUSA249612	24	96	24	700
		CHH MS				
 <p>LOCKERS/TALL UTILITY</p> <ul style="list-style-type: none"> <li>•24" Deep</li> <li>•2 Doors - Type "A"</li> </ul> <p>Specify Left or Right Hinge</p> <ul style="list-style-type: none"> <li>•Includes One Fixed Shelf</li> <li>•No Adjustable shelves</li> <li>•Lower doors are approximately 59" high</li> </ul> <p>Coat Hooks Mel Adj Shelf Roll-Out Tray Add a drawer</p>	6	TUSA1284	12	84	24	630
		TUSA1884	18	84	24	650
		TUSA2484	24	84	24	680
		TUSA1296	12	84	24	680
		TUSA1896	18	96	24	710
		TUSA2496	24	96	24	1110
		CHH MS ROT DRAWER				
 <p>TYPE "A"</p> <p>Note: Make note if doors are to line up with other doors.</p>						

Additional Depths      25" to 27" add 10%      Fractions      Add \$125 per cabinet  
                                  28" to 30" add 15%      Custom Items      Add 30% to cabinet price  
                                  31" to 33" add 20%

Interior Options Black and Almond Melamine - add 10% of case  
                                  Stock Melamine Colors - add 25% of case  
                                  Finished Wood and other Melamine Colors - Double price of case

Additional Melamine Shelves - MS - \$25 each

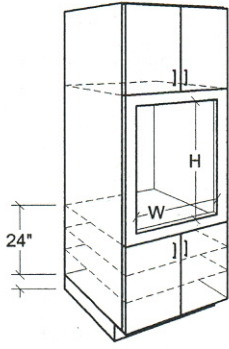
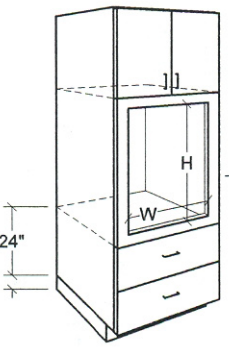
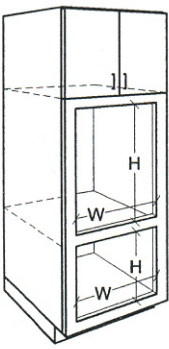
		SHELVES	CODE	W	H	D	PRICE	
 <p><b>TALL SINGLE OVEN</b></p> <ul style="list-style-type: none"> <li>•4 Doors</li> <li>•Includes Face Frame</li> </ul> <p>Opening Sizes <b>MUST</b> be shown</p> <p>Face Frames are made only from specs</p>	2	TSO2484 TSO3084 TSO3684	24 30 36	84 84 84	24 24 24	1330 1360 1390		
			TSO2496 TSO3096 TSO3696	24 30 36	96 96 96	24 24 24	1400 1430 1460	
		SINGLE OVEN FACE FRAME ONLY	OFTS				120	
	 <p><b>TALL SINGLE OVEN DRAWER</b></p> <ul style="list-style-type: none"> <li>•2 Doors</li> <li>•2 Drawers</li> <li>•Includes Face Frame</li> </ul> <p>Opening Sizes <b>MUST</b> be shown</p> <p>Face Frames are made only from specs</p>	0	TSOD2484 TSOD3084 TSOD3684	24 30 36	84 84 84	24 24 24	1410 1450 1470	
				TSOD2496 TSOD3096 TSOD3696	24 30 36	96 96 96	24 24 24	1480 1520 1540
			SINGLE OVEN FACE FRAME ONLY	OFTS				120
		 <p><b>TALL DOUBLE OVEN</b></p> <ul style="list-style-type: none"> <li>•2 Doors</li> <li>•Includes Face Frame</li> </ul> <p>Opening Sizes <b>MUST</b> be shown</p> <p>Face Frames are made only from specs</p>	0	TDO2484 TDO3084 TDO3684	24 30 36	84 84 84	24 24 24	1180 1210 1230
				TDO2496 TDO3096 TDO3696	24 30 36	96 96 96	24 24 24	1240 1270 1290
			DOUBLE OVEN FACE FRAME ONLY	OFTD				200

Additional Depths      25" to 27" add 10%  
                                  28" to 30" add 15%  
                                  31" to 33" add 20%

Fractions                Add \$125 per cabinet  
 Custom Items        Add 30% to cabinet price

Interior Options Black and Almond Melamine - add 10% of case  
 Stock Melamine Colors - add 25% of case  
 Finished Wood and other Melamine Colors - Double price of case  
 Additional Melamine Shelves - MS - \$25 each

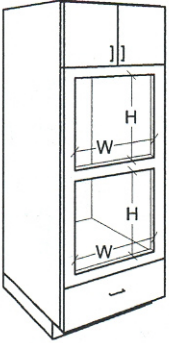
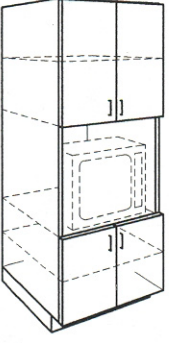
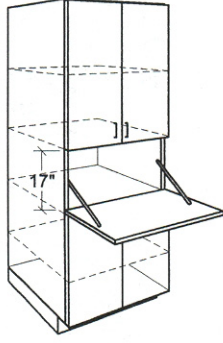
		SHELVES	CODE	W	H	D	PRICE
 <p><b>TALL DOUBLE OVEN</b></p> <ul style="list-style-type: none"> <li>•2 Doors</li> <li>•2 Drawers</li> <li>•Includes Face Frame</li> </ul> <p>Opening Sizes <b>MUST</b> be shown</p> <p>Face Frames are made only from specs</p>	0	TDOD2484 TDOD3084 TDOD3684	24 30 36	84 84 84	24 24 24	1200 1230 1250	
		TDOD2496 TDOD3096 TDOD3696	24 30 36	96 96 96	24 24 24	1260 1290 1310	
		OFTD				200	
	 <p><b>TV ENTERTAINMENT CENTER</b></p> <ul style="list-style-type: none"> <li>•4 Doors</li> <li>•2 Adjustable Shelves</li> </ul> <p>This cabinet is made in 3" pieces For 27" deep ADD \$100 For 30" deep ADD \$130</p> <p>TV Pull &amp; Swivel - 150 lbs limit - TV swivels <b>MUST</b> be bolted down</p> <p>Pocket Door Slide -add for door</p> <p>Interior cabinet width with pocket doors - deduct 2-3/4" per door.</p>	2	TVC3084 TVC3684 TVC4284	30 36 42	84 84 84	24 24 24	1000 1050 1100
			TVC3096 TVC3696 TVC4296	30 36 42	96 96 96	24 24 24	1050 1100 1150
			TVS				400
			PD				350
 <p><b>TALL UTILITY</b></p> <ul style="list-style-type: none"> <li>•4 Doors</li> <li>•1 Fold-Down Door</li> <li>•2 Adjustable Shelves</li> <li>•Wood interior in center section included</li> </ul> <p>This cabinet is made in 3 pieces</p>		2	TUC3084 TUC3684 TUC4284	30 36 42	84 84 84	24 24 24	1000 1050 1100
			TUC3096 TUC3696 TUC4296	30 36 42	96 96 96	24 24 24	1050 1100 1150

Additional Depths      25" to 27" add 10%  
                                  28" to 30" add 15%  
                                  31" to 33" add 20%

Interior Options Black and Almond Melamine - add 10% of case  
 Stock Melamine Colors - add 25% of case  
 Finished Wood and other Melamine Colors - Double price of case

Additional Melamine Shelves - MS - \$25 each

Fractions              Add \$125 per cabinet  
 Custom Items        Add 30% to cabinet price

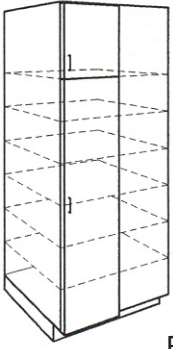
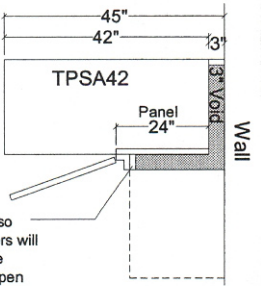
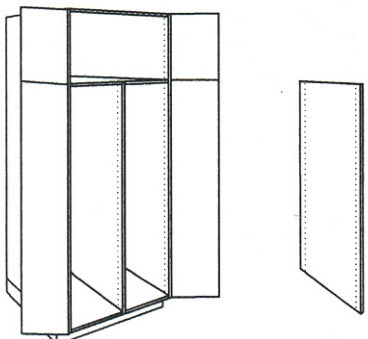
	SHELVES	CODE	W	H	D	PRICE
 <p><b>TALL BLIND CORNER</b></p> <ul style="list-style-type: none"> <li>•2 Doors</li> <li>Specify Type A, B, or C</li> <li>Specify Left or Right (Left Illustrated)</li> </ul> <p>Requires a Tall Corner Overlay Filler</p>  <p>Use a 3" filler so doors &amp; drawers will have adequate clearance to open properly.</p>		TBLIND				Add \$100 to Pantry Price
		TCOF				300
<p><b>DIVIDER TALL PANTRY</b></p> 		DIVT				200

Additional Depths      25" to 27" add 10%  
                                  28" to 30" add 15%  
                                  31" to 33" add 20%

Interior Options Black and Almond Melamine - add 10% of case  
 Stock Melamine Colors - add 25% of case  
 Finished Wood and other Melamine Colors - Double price of case

Additional Melamine Shelves - MS - \$25 each

Fractions              Add \$125 per cabinet  
 Custom Items        Add 30% to cabinet price

**TALL CABINETS**

*Carriage House, Fine Kitchen Cabinetry*

**5.9**

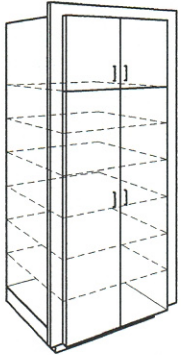
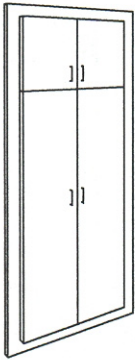
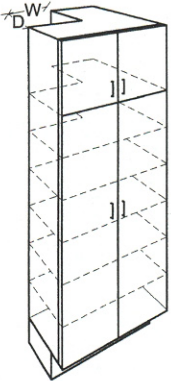
		SHELVES	CODE	W	H	D	PRICE
 <p><b>TALL PANTRY FRAMED</b></p> <ul style="list-style-type: none"> <li>•Price as Pantry</li> <li>•Add Face Frame</li> </ul>			FRAME				18 PER SQ. FT.
 <p><b>TALL FACE FRAME</b></p> <ul style="list-style-type: none"> <li>•Add Doors</li> </ul>			FRAME				18 PER SQ. FT.
 <p><b>FACTORY NOTCH</b></p> <p>Specify Notch Dimensions</p>			NOTCH				200

Additional Depths      25" to 27" add 10%      Fractions      Add \$125 per cabinet  
                                  28" to 30" add 15%      Custom Items      Add 30% to cabinet price  
                                  31" to 33" add 20%

Interior Options Black and Almond Melamine - add 10% of case  
                                  Stock Melamine Colors - add 25% of case  
                                  Finished Wood and other Melamine Colors - Double price of case

Additional Melamine Shelves - MS - \$25 each

**TALL CABINETS**

*Carriage House, Fine Kitchen Cabinetry*

**5.10**

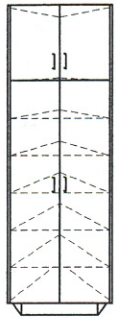
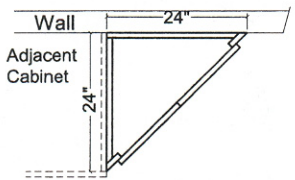
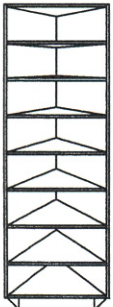
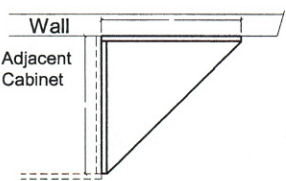
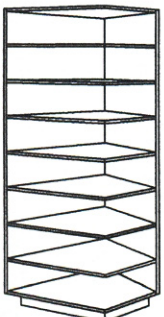
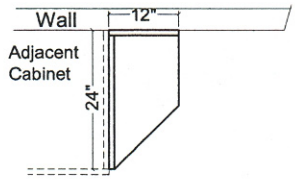
		SHELVES	CODE	W	H	D	PRICE
 <p><b>TALL ANGLE 45</b>                      •4 Doors                      Specify Type A, B, or C                      •Includes 1 Fixed Shelf</p> 	6	TAC242484 TAC242496	24 24	84 96	24 24	1100 1250	
	 <p><b>TALL ANGLE OPEN SHELVES</b>                      •Includes Wood Interior                      •NO face frame</p> 	6	TAOS121284 TAOS121296	12 12	84 96	12 12	930 980
		TAOS242484 TAOS242496	24 24	84 96	24 24	1150 1200	
 <p><b>TALL ANGLE OPEN SHELVES</b>                      •Includes Wood Interior                      •NO face frame</p> 		6	TAOS122484 TAOS122396	12 12	84 96	24 24	1130 1180

Additional Depths      25" to 27" add 10%  
 28" to 30" add 15%  
 31" to 33" add 20%

Fractions              Add \$125 per cabinet  
 Custom Items        Add 30% to cabinet price

Interior Options Black and Almond Melamine - add 10% of case  
 Stock Melamine Colors - add 25% of case  
 Finished Wood and other Melamine Colors - Double price of case

Additional Melamine Shelves - MS - \$25 each

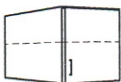
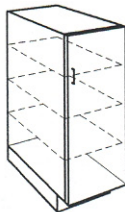
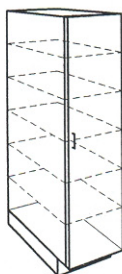
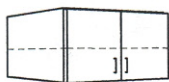
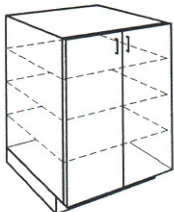
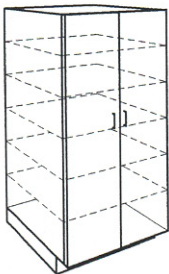

		SHELVES	CODE	W	H	D	PRICE
	TALL SECTION	1	TS1224	12	24	24	215
	<ul style="list-style-type: none"> <li>•Designed to be Stacked</li> <li>•24" Deep</li> </ul>		TS1824	18	24	24	222
			TS2424	24	24	24	227
	TALL SECTION	3	TS1248	12	48	24	430
	<ul style="list-style-type: none"> <li>•Designed to be Stacked</li> <li>•24" Deep</li> <li>•1 Door</li> </ul>		TS1848	18	48	24	444
			TS2448	24	48	24	454
	TALL SECTION	4	TS1272	12	72	24	675
	<ul style="list-style-type: none"> <li>•Designed to be Stacked</li> <li>•24" Deep</li> <li>•1 Door</li> </ul>		TS1872	18	72	24	696
			TS2472	24	72	24	711
	TALL SECTION	1	TS2424	24	24	24	255
	<ul style="list-style-type: none"> <li>•Designed to be Stacked</li> <li>•24" Deep</li> </ul>		TS3024	30	24	24	365
			TS3624	36	24	24	385
			TS4224	42	24	24	400
	TALL SECTION	3	TS2448	24	48	24	520
	<ul style="list-style-type: none"> <li>•Designed to be Stacked</li> <li>•24" Deep</li> <li>•2 Doors</li> </ul>		TS3048	30	48	24	540
			TS3648	36	48	24	554
			TS4248	42	48	24	640
	TALL SECTION	5	TS2472	24	72	24	780
	<ul style="list-style-type: none"> <li>•Designed to be Stacked</li> <li>•24" Deep</li> <li>•2 Doors</li> </ul>		TS3072	30	72	24	810
			TS3672	36	72	24	831
			TS4272	42	72	24	960

Additional Depths      25" to 27" add 10%  
 28" to 30" add 15%  
 31" to 33" add 20%

Fractions              Add \$125 per cabinet  
 Custom Items        Add 30% to cabinet price

Interior Options Black and Almond Melamine - add 10% of case  
 Stock Melamine Colors - add 25% of case  
 Finished Wood and other Melamine Colors - Double price of case

Additional Melamine Shelves - MS - \$25 each

	<b>CODE</b>	<b>PRICE</b>
<p><b>CUSTOM ITEMS</b> Not shown in book: add 30% to cabinet price</p>		30%
<p><b>MIXED COLORS IN SINGLE CABINET</b> When mixing more than one color on one cabinet: add 35% to cabinet price</p>		50%
<p><b>MIXED COLORS IN SINGLE CABINET</b> When mixing more than two colors in one room: add 75% to cabinet price of all cabinets of the 3rd, 4th, etc. color</p>		75%
<p><b>HARDWARE</b> When pulls are drilled on job site: add 4.00 per pull</p>		4

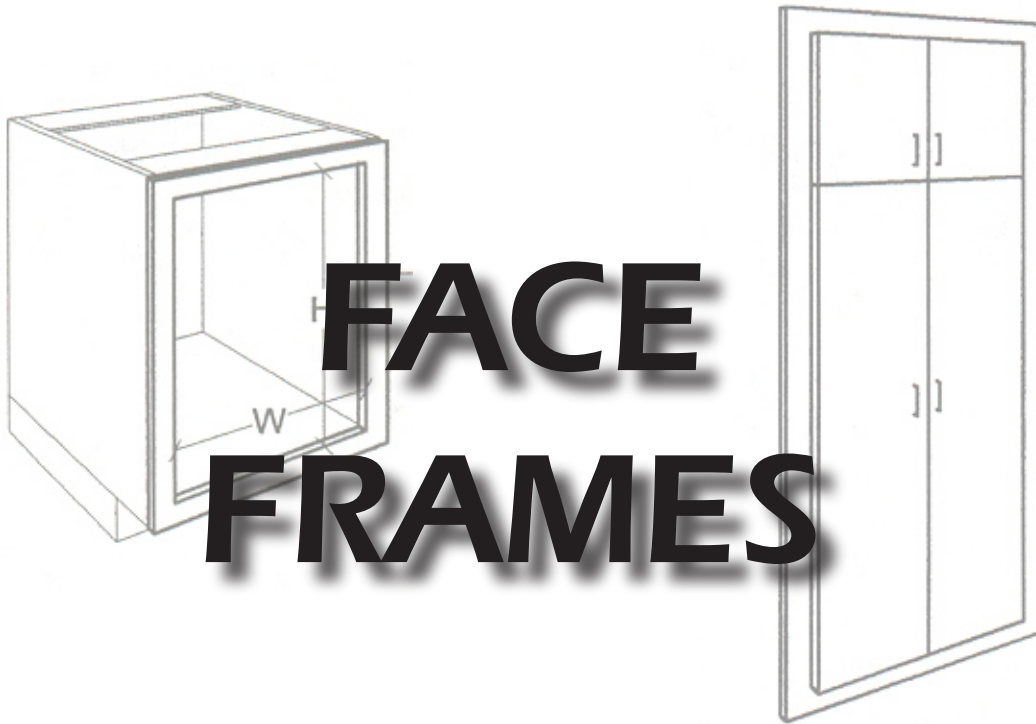

# FACE FRAMES



*Carriage House*  
*Fine Kitchen Cabinetry*

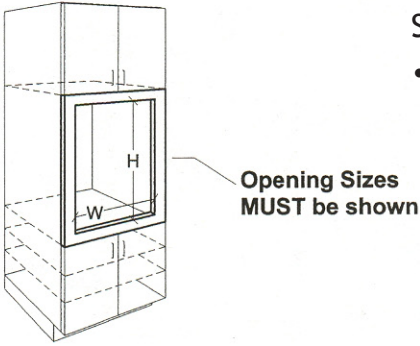
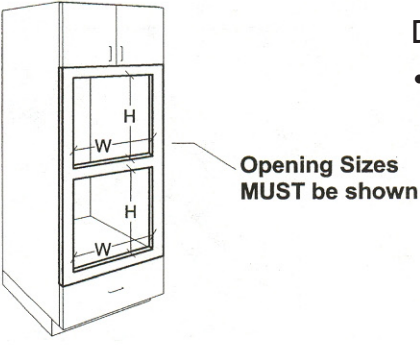
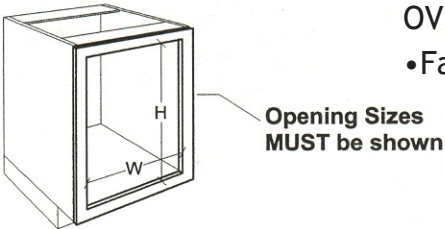
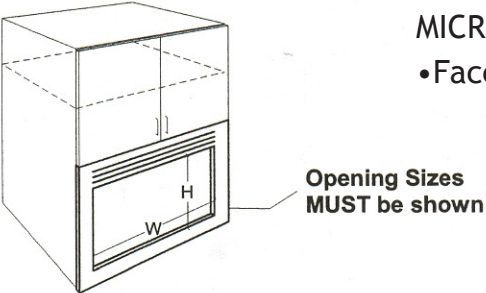

		<b>CODE</b>	<b>PRICE</b>
 <p><b>SINGLE OVEN FRAME</b> •Face Frames are made only from specs</p>	OFTS	120	
 <p><b>DOUBLE OVEN FRAME</b> •Face Frames are made only from specs</p>	OFTD	200	
 <p><b>OVEN FRAME</b> •Face Frames are made only from specs</p>	OF	190	
 <p><b>MICROWAVE FRAME</b> •Face Frames are made only from specs</p>	OFM	120	
<ul style="list-style-type: none"> <li>•Face Frames include matching outside edge</li> <li>•Add 12 per square foot for E17 outside edge</li> <li>•Add 50% of frame for inside edge</li> <li>•Add 50% of frame for angle</li> </ul>			12 PER SQ. FT 50% 50%

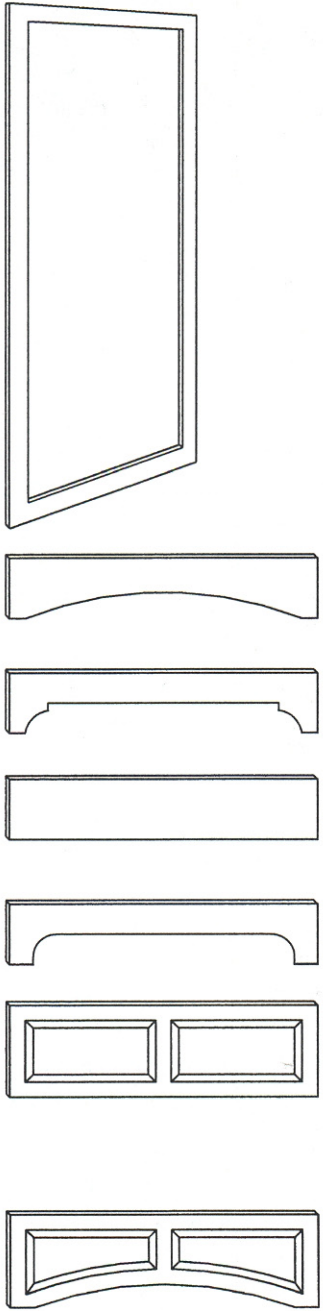
		CODE	PRICE	
 <p><b>FACE FRAMES</b> *MINIMUM CHARGE 150 PER FRAME •Face Frames are made only from specs</p> <p>Add Valance for Special Face Frame Top Rails MINIMUM CHARGE 200 PER VALENCE</p>		FRAME	*18 PER SQ. FT.	
		VAL001	100 PER FT.	
		VAL002	125 PER FT.	
		VAL004	50 PER FT.	
		VAL006	125 PER FT.	
	UP TO 16" HIGH	VAL007A VAL007B VAL007C	125 PER FT. 135 PER FT. 145 PER FT.	
	17" TO 24" HIGH	VAL007AT VAL007BT VAL007CT	145 PER FT. 155 PER FT. 165 PER FT.	
	UP TO 16" HIGH	VAL008A VAL008B VAL008C	170 PER FT. 180 PER FT. 190 PER FT.	
	17" TO 24" HIGH	VAL008AT VAL008BT VAL008CT	190 PER FT. 200 PER FT. 210 PER FT.	
	<ul style="list-style-type: none"> <li>•Face Frames include matching outside edge</li> <li>•Add 12 per square foot for E17 outside edge</li> <li>•Add 50% of frame for inside edge</li> <li>•Add 50% of frame for angle</li> </ul>			12 PER SQ. FT. 50% 50%

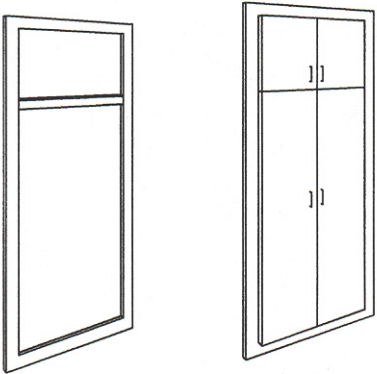
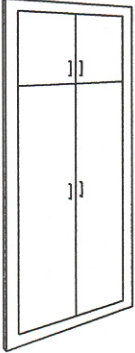
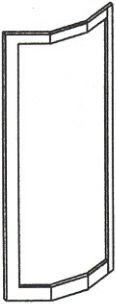
		CODE	PRICE
 <p><b>FACE FRAME FOR DOORS</b>                      *MINIMUM CHARGE 100 PER FRAME                      •Square Inside Frame Edge</p> <p>Add for Doors</p>	FRAME	*18 PER SQ. FT.	
 <p><b>FACE FRAME FOR INSET DOORS</b>                      *MINIMUM CHARGE 100 PER FRAME</p> <p>Square Inside Frame Edge</p> <p>E17 Match Inside Frame Edge</p> <p>Add for Doors</p>	FRAME INSETSQ  FRAME INSETE17	*25 PER SQ. FT.  *35 PER SQ. FT.	
 <p><b>ANGLED FACE FRAMES</b>                      *MINIMUM CHARGE 100 PER FRAME                      •Square Inside Frame Edge</p>	FRAMEANG	*18 PER SQ. FT.  ADD 50% OF CABINET AND 50% OF FACE FRAME PER ANGLE	
<ul style="list-style-type: none"> <li>•Face Frames include matching outside edge</li> <li>•Add 12 per square foot for E17 outside edge</li> <li>•Add 50% of frame for inside edge</li> <li>•Add 50% of frame for angle</li> </ul>			12 PER SQ. FT. 50% 50%

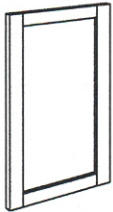
	CODE	PRICE
 <p><b>MIRROR FRAME</b>                      *MINIMUM CHARGE 100 PER FRAME                      •Square Inside Frame Edge                      •Does not include mirror</p>	MIRF	*18 PER SQ. FT.
<ul style="list-style-type: none"> <li>•Face Frames include matching outside edge</li> <li>•Add 12 per square foot for E17 outside edge</li> <li>•Add 50% of frame for inside edge</li> <li>•Add 50% of frame for angle</li> </ul>		12 PER SQ. FT 50% 50%



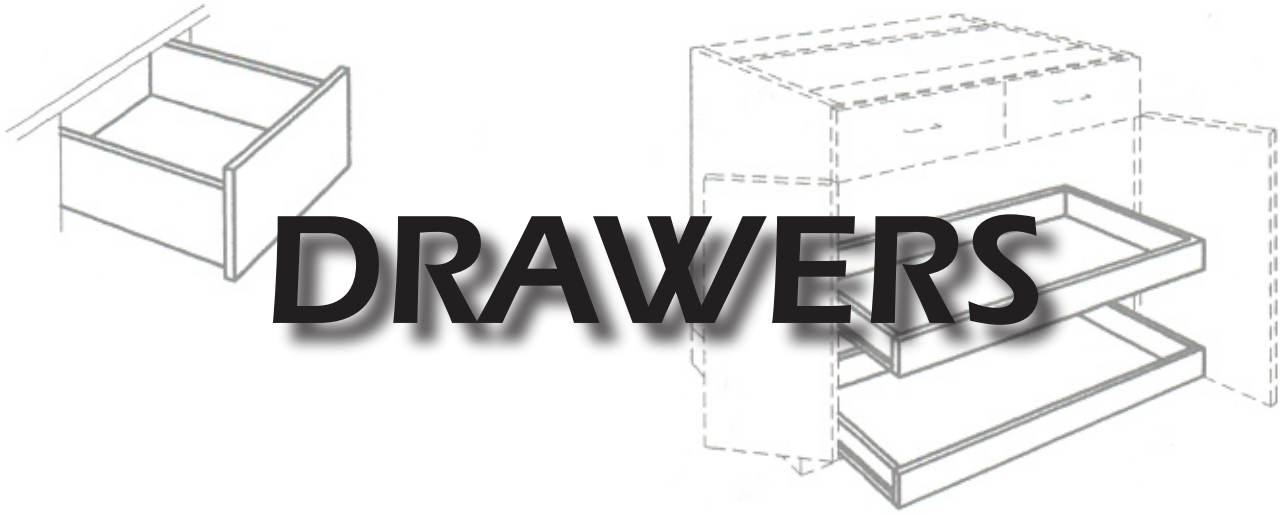

# DRAWERS





*Carriage House*  
*Fine Kitchen Cabinetry*

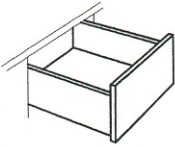
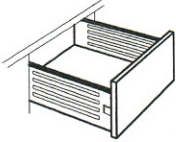
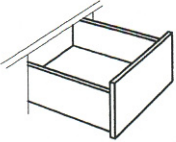
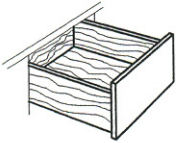
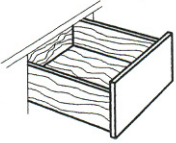
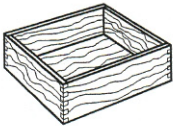

**DRAWERS***Carriage House, Fine Kitchen Cabinetry***7.1**

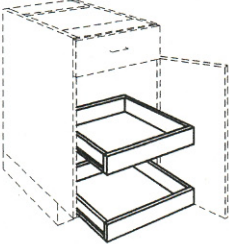
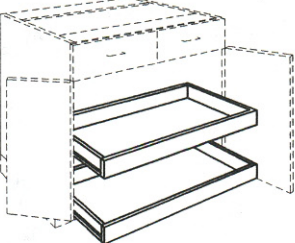
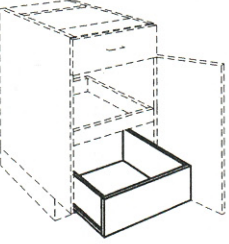
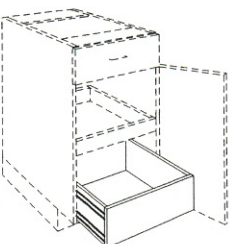
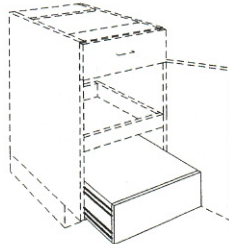
		<b>CODE</b>	<b>PRICE</b>
	<p><b>DRAWER</b></p> <ul style="list-style-type: none"> <li>•Standard •5/8 White Melamine</li> <li>•Full Extension Glides Included</li> </ul> <p>Add for Upgrade Guides Add for Extra Drawers</p>	DRAWER	150
	<p><b>DRAWER</b></p> <ul style="list-style-type: none"> <li>•Standard •Metal Box - Blum</li> </ul> <p>Add for Extra Drawers</p>	DRAWER	150
	<p><b>DRAWER</b></p> <ul style="list-style-type: none"> <li>•Upgrade</li> <li>•5/8 Black or Almond Melamine</li> <li>•Full Extension Glides Included</li> </ul> <p>Add for Upgrade Guides</p>	DRAWERBA	ADD 10 PER DRAWER
	<p><b>DRAWER -- SPECIAL ORDER</b></p> <ul style="list-style-type: none"> <li>•Upgrade</li> <li>•3/4" Wood Grained Melamine in Stock Colors</li> <li>•Full Extension Glides Included</li> </ul> <p>Add for Upgrade Guides</p>	DRAWERWG	ADD 35 PER DRAWER
	<p><b>DRAWER</b></p> <ul style="list-style-type: none"> <li>•Upgrade</li> <li>•5/8" Baltic Birch</li> <li>•Full Extension Glides Included</li> </ul> <p>Add for Upgrade Guides</p>	BALTIC	ADD 75 PER DRAWER
	<p><b>DRAWER</b></p> <ul style="list-style-type: none"> <li>•Upgrade</li> <li>•5/8" Maple Dovetail</li> <li>•Full Extension Glides Included</li> </ul> <p>Add for Upgrade Guides</p>	DOVETAIL	ADD 150 PER DRAWER
<p>Melamine Stock Colors HARDROCK MAPLE - W290 ALCOVE WALNUT - W685 AMBER WOOD - W181</p>			

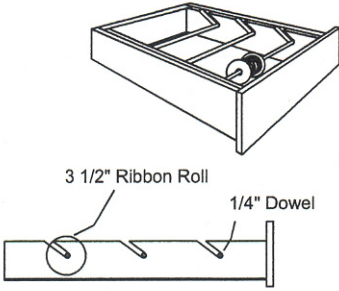
		CODE	PRICE
	<p>ROLL-OUT TRAY DRAWER STANDARD</p> <ul style="list-style-type: none"> <li>•100 lb. Capacity</li> <li>•Includes 1" Distance Blocks</li> <li>•5/8" Construction</li> <li>•Maximum width for standard ROT is 30"</li> </ul>	ROT	200
	<p>ROLL-OUT TRAY DRAWER OVERSIZED</p> <ul style="list-style-type: none"> <li>•150 lb. Capacity</li> <li>•Includes 1" Distance Blocks</li> <li>•5/8" Construction</li> <li>•Sizes 31" to 42"</li> </ul>	ROTOV	285
	<p>ROLL-OUT TRAY DRAWER 6"</p> <ul style="list-style-type: none"> <li>•Includes 1" Distance Blocks</li> <li>•6" deep Drawer</li> </ul>	ROT6	250
	<p>DOUBLE SLIDE ROLL-OUT TRAY Add for extra slide</p> <p><i>Double slide system to add stability and strength</i></p>	ROTEXS	25
	<p>DOUBLE SLIDE ROLL-OUT TRAY Add for Flush Top</p> <p><i>Double slide system to add stability and strength</i></p>	ROTFT	75

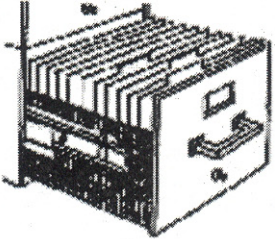
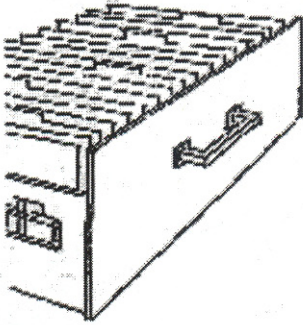
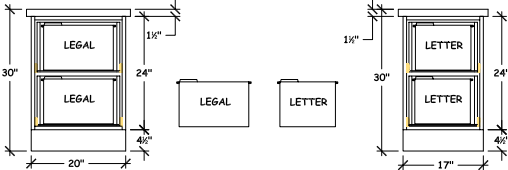
		CODE	PRICE
 <p><b>RIBBON DRAWER</b></p> <ul style="list-style-type: none"> <li>•Includes 3 Dowels</li> </ul>		RD	130
	 <p><b>LINEN DRAWER</b></p> <ul style="list-style-type: none"> <li>•Maple with Natural Finish.</li> <li>•Includes Full Extension Guides</li> <li>•Includes 5 dowels</li> </ul> <p>Add for additional dowels</p>	LD	400
		DOWEL	50
 <p><b>FILE DRAWER</b></p> <ul style="list-style-type: none"> <li>•17" Min for Letter</li> <li>•20" Min for Legal</li> </ul> <p>100 lb. capacity</p> <p><i>All files must be indicated Letter or Legal</i></p>	RFA	320	
		see also VF and BF	
 <p><b>LATERAL FILE DRAWER</b></p> <ul style="list-style-type: none"> <li>•18" deep Min for Letter</li> <li>•21" deep Min for Legal</li> </ul> <ul style="list-style-type: none"> <li>•Includes File Racks</li> <li>•Includes Full Extension Guides</li> </ul> <p><i>All files must be indicated Letter or Legal</i></p>	LFA24 LFA30	320 350	
		see also VFL and BFL	
			

**DRAWERS***Carriage House, Fine Kitchen Cabinetry***7.4**

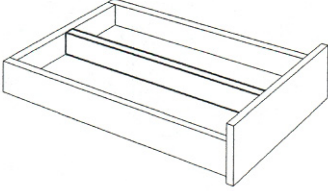
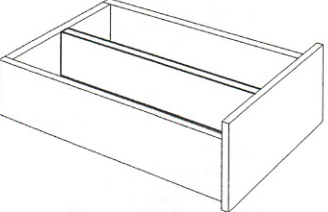
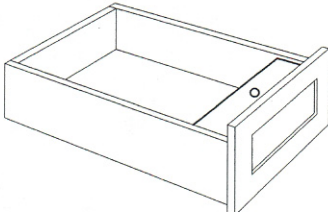
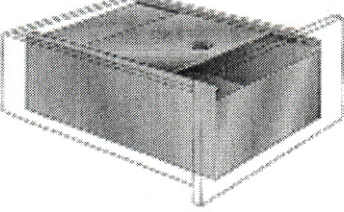
		CODE	PRICE
	<p><b>DRAWER DIVIDER 3"</b></p> <ul style="list-style-type: none"> <li>•Indicate Spacing</li> </ul>	DD3	30
	<p><b>DRAWER DIVIDER 6"</b></p> <ul style="list-style-type: none"> <li>•Indicate Spacing</li> </ul>	DD6	40
	<p><b>GRAIN BIN</b></p> <ul style="list-style-type: none"> <li>•3/16" Plexi Hinged Lid</li> <li>•3" Deep</li> </ul>	GB	220
	<p><b>METAL LINER</b></p> <p>Custom Sizes</p>	<p>ML</p> <p>MLD</p>	<p>200</p> <p>225</p>

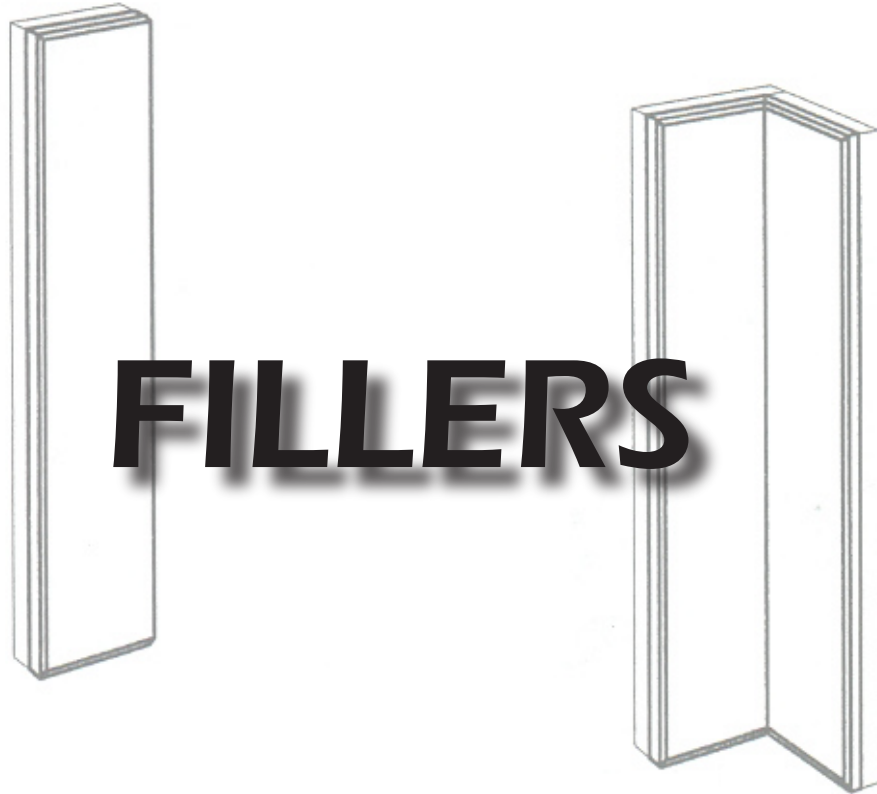

# FILLERS



*Carriage House*  
*Fine Kitchen Cabinetry*





**FILLERS**

*Carriage House, Fine Kitchen Cabinetry*

**8.1**

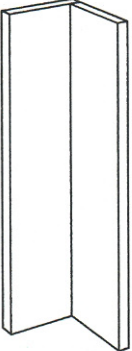
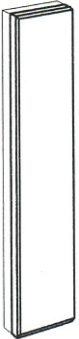
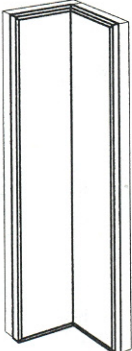
		TYPE	CODE	W	H	D	PRICE
 <p><b>FILLER</b></p> <ul style="list-style-type: none"> <li>•3" Wide</li> <li>•Solid Wood</li> <li>•Square Edges</li> </ul>	WALL	WF330	3	30		30	
		WF342	3	42		40	
		WF360	3	60		50	
	BASE	BF330	3	30		30	
		BF342	3	42		40	
		BF360	3	60		50	
	TALL	TF384	3	84		60	
		TF396	3	96		60	
		TF3108	3	108		75	
 <p><b>CORNER FILLER</b></p> <ul style="list-style-type: none"> <li>•3" X 3"</li> <li>•Solid Wood</li> <li>•Square Edges</li> <li>•Cut to size on site</li> </ul> <p>•Inside 45° corner •Inside 90° corner</p>	WALL	WCF3330	3	30	3	65	
		WCF3342	3	42	3	85	
		WCF3360	3	60	3	105	
	BASE	BCF3330	3	30	3	65	
	TALL	TCF3384	3	84	3	130	
		TCF3396	3	96	3	130	
		TCF33108	3	108	3	160	
	 <p><b>OVERLAY FILLER</b></p> <ul style="list-style-type: none"> <li>•3" X 3"</li> <li>•Solid Wood</li> <li>•Edge Matches Door on 3 sides</li> <li>•Includes 3/4" back</li> </ul>	WALL	WOF330	3	30		60
			WOF342	3	42		80
		WOF360	3	60		100	
BASE		BOF330	3	30		60	
		BOF342	3	42		80	
		BOF360	3	60		100	
TALL		TOF384	3	84		120	
		TOF396	3	96		120	
		TOF3108	3	108		150	
 <p><b>CORNER OVERLAY FILLER</b></p> <ul style="list-style-type: none"> <li>•3" X 3"</li> <li>•Solid Wood</li> <li>•Edges Match Door</li> <li>•Cut to size on site</li> </ul> <p>•Inside 45° corner •Inside 90° corner</p>	WALL	WCOF3330	3	30	3	130	
		WCOF3342	3	42	3	170	
		WCOF3360	3	60	3	210	
	BASE	BCOF3330	3	30	3	130	
	TALL	TCOF3384	3	84	3	300	
		TCOF3396	3	96	3	300	
		TCOF33108	3	108	3	360	

E17 Edge Add \$12 per foot

**FILLERS**

*Carriage House, Fine Kitchen Cabinetry*

**8.2**

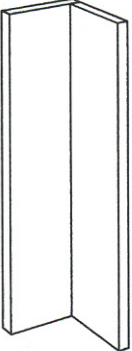
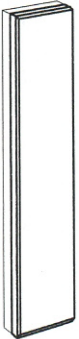
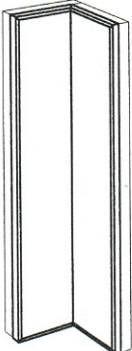
		TYPE	CODE	W	H	D	PRICE
 <p><b>FILLER</b></p> <ul style="list-style-type: none"> <li>•6" Wide</li> <li>•Solid Wood</li> <li>•Square Edges</li> </ul>	WALL	WF630	6	30		45	
		WF642	6	42		60	
		WF660	6	60		75	
	BASE	BF630	6	30		45	
		BF642	6	42		60	
		BF660	6	60		75	
	TALL	TF684	6	84		90	
		TF696	6	96		90	
		TF6108	6	108		115	
 <p><b>CORNER FILLER</b></p> <ul style="list-style-type: none"> <li>•6" X 6"</li> <li>•Solid Wood</li> <li>•Square Edges</li> <li>•Cut to size on site</li> </ul> <p>•Inside 45° corner •Inside 90° corner</p>	WALL	WCF6630	6	30	6	98	
		WCF6642	6	42	6	128	
		WCF6660	6	60	6	158	
	BASE	BCF6630	6	30	6	98	
	TALL	TCF6684	6	84	6	195	
		TCF6696	6	96	6	195	
		TCF66108	6	108	6	240	
	 <p><b>OVERLAY FILLER</b></p> <ul style="list-style-type: none"> <li>•6" X 6"</li> <li>•Solid Wood</li> <li>•Edge Matches Door on 3 sides</li> <li>•Includes 3/4" back</li> </ul>	WALL	WOF630	6	30		90
			WOF642	6	42		120
		WOF660	6	60		150	
BASE		BOF630	6	30		90	
		BOF642	6	42		120	
		BOF660	6	60		150	
TALL		TOF684	6	84		180	
		TOF696	6	96		180	
		TOF6108	6	108		225	
 <p><b>CORNER OVERLAY FILLER</b></p> <ul style="list-style-type: none"> <li>•6" X 6"</li> <li>•Solid Wood</li> <li>•Edges Match Door</li> <li>•Cut to size on site</li> </ul> <p>•Inside 45° corner •Inside 90° corner</p>	WALL	WCOF6630	6	30	6	195	
		WCOF6642	6	42	6	255	
		WCOF6660	6	60	6	315	
	BASE	BCOF6630	6	30	6	195	
	TALL	TCOF6684	6	84	6	450	
		TCOF6696	6	96	6	450	
		TCOF66108	6	108	6	540	

E17 Edge Add \$12 per foot

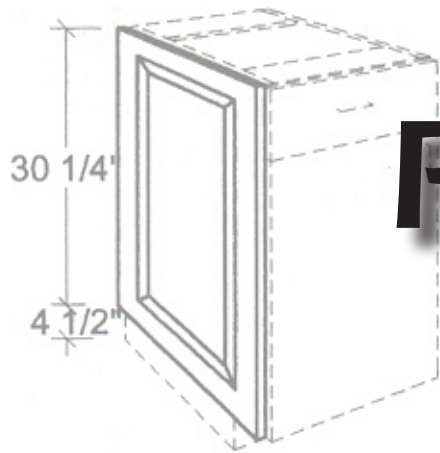

# PANELS



*Carriage House*  
*Fine Kitchen Cabinetry*

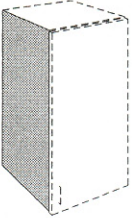
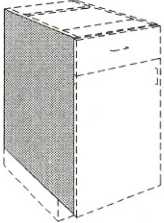
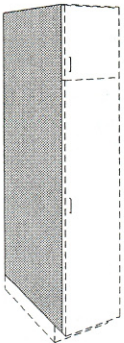

	<b>CODE</b>	<b>D</b>	<b>H</b>	<b>PRICE</b>
 <p><b>WALL CABINET FINISHED SIDE</b></p> <p>•Price as WEP</p>	WEP1212 to WEP1236	12	12 to 36	60
	WEP1237 to WEP1260	12	37 to 60	90
	WEP1812 to WEP1836	18	12 to 36	80
	WEP1837 to WEP1860	18	37 to 60	120
	WEP2412 to WEP2436	24	12 to 36	100
	WEP2437 to WEP2460	24	37 to 60	150
 <p><b>BASE CABINET FINISHED SIDE</b></p> <p>•Price as BEP</p>	BEP	24	30	100
 <p><b>TALL CABINET FINISHED SIDE</b></p> <p>•Price as TEP</p>	TEP384 to TEP1196	3 to 11	84 to 96	160
	TEP1284 to TEP2496	12 to 24	84 to 96	210
	TEP2584 to TEP3096	25 to 30	84 to 96	280

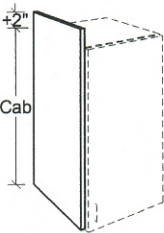
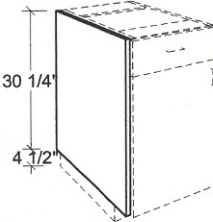
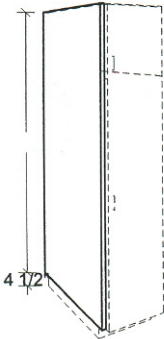
	<b>CODE</b>	<b>D</b>	<b>H</b>	<b>PRICE</b>
 <p><b>WALL END PANEL</b></p> <ul style="list-style-type: none"> <li>•Veneer Panel with Edge</li> </ul> <p>Specify Cabinet Size WEP is 1" Deeper and 2" higher than cabinet</p>	WEP612 to WEP660	6	12 to 60	45
	WEP1212 to WEP1236	12	12 to 36	60
	WEP1237 to WEP1260	12	37 to 60	90
	WEP1812 to WEP1836	18	12 to 36	80
	WEP1837 to WEP1860	18	37 to 60	120
	WEP2412 to WEP2436	24	12 to 36	100
	WEP2437 to WEP2460	24	37 to 60	150
 <p><b>BASE END PANEL</b></p> <ul style="list-style-type: none"> <li>•Veneer Panel with Edge</li> </ul> <p>Specify Cabinet Size BEP is 1" deeper than cabinet</p> <p>Specify if BEP is to the floor</p> <p>Veneer Panel with Edge finished 2 sides</p>	BEP 6	6	30-1/4	75
	BEP	24	30-1/4	100
	BEPF	24	34-1/2	100
	DSEP	24	25 to 36	120
 <p><b>TALL END PANEL</b></p> <p>Specify Cabinet Size TEP is 1" Deeper than cabinet</p> <p>Specify if TEP is to the floor</p>	TEP384 to TEP1196	3 to 11	84 to 96	160
	TEP1284 to TEP2496	12 to 24	84 to 96	210
	TEP2584 to TEP3096	25 to 30	84 to 96	280
	TEP3108 to TEP11108	3 to 11	97 - 108	210
	TEP12108 to TEP24108	12 to 24	97 - 108	280
	TEP25108 to TEP30108	25 to 30	97 - 108	350

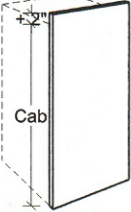
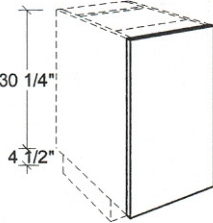
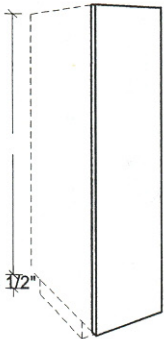
	<b>CODE</b>	<b>D</b>	<b>H</b>	<b>PRICE</b>
 <p><b>WALL BACK PANEL</b></p> <ul style="list-style-type: none"> <li>•Veneer Panel</li> </ul> <p>Specify Cabinet Size WBP is 2" Higher than Cabinet</p>	WBP			26 PER SQ. FT.
 <p><b>BASE BACK PANEL</b></p> <ul style="list-style-type: none"> <li>•Veneer Panel with Edge</li> <li>•Add for Corbels</li> <li>•Add Corbels after installation 150</li> <li>•Specify if BBP is to the floor</li> </ul>	BBP  CORBEL  BBPF			26 PER SQ. FT.  100 150  26 PER SQ. FT.
 <p><b>TALL BACK PANEL</b></p> <ul style="list-style-type: none"> <li>•Veneer Panel</li> </ul> <p>Specify if TBP is to the floor</p>	TBP  TBPF			26 PER SQ. FT.  26 PER SQ. FT.

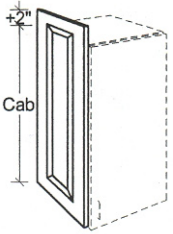
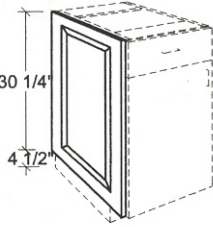
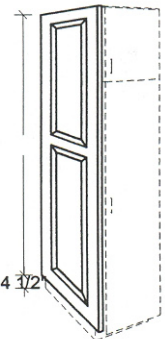
		CODE	D	H	PRICE
 <p>WALL END PANEL MATCH "A" Panels match group "A" Doors</p> <p>Specify Cabinet Size WEPMA is 1" Deeper and 2" Higher than Cabinet</p>		WEPMA1212 to WEPMA1236 WEPMA1237 to WEPMA1260	12 12	12 to 36 37 to 60	120 160
		WEPMA1812 to WEPMA1836 WEPMA1837 to WEPMA1860	18 18	12 to 36 37 to 60	140 180
		WEPMA2412 to WEPMA2436 WEPMA2437 to WEPMA2460	24 24	12 to 36 37 to 60	200 220
 <p>BASE END PANEL MATCH "A" Panels match group "A" Doors</p> <p>Specify Cabinet Size BEPMA is 1" Deeper than Cabinet</p> <p>•Price includes plain solid BEP</p> <p>Specify if BEPMA is to the floor</p>		BEPMA	24	25 to 36	180
		BEPMAF	24	25 to 36	180
 <p>TALL END PANEL MATCH "A"</p> <p>Specify Cabinet Size TEPMA is 1" Deeper than Cabinet</p> <p>Price includes plain solid TEP</p> <p>Specify if TEPMA is to the floor</p>		TEPMA384 to TEPMA1196 TEPMA1284 to TEPMA2496 TEPMA2584 to TEPMA3096	3 to 11 12 to 24 25 to 30	84 to 96 84 to 96 84 to 96	360 560 760
		TEPMA397 to TEPMA11108 TEPMA1297 - TEPMA24108 TEPMA2597 - TEPMA30108	3 to 11 12 to 24 25 to 30	97 - 108 97 - 108 97 - 108	460 660 860

<b>GROUP "A" DOORS</b>	Aladdin	Raised	Manhattan	True Raised	Raised
	Bead Board	No Frame	Oxford	Waterford	Raised
	Bradford	Flat	Oxford	Waterford	Flat
	Downs	Raised	Shaker	Windsor	Raised
	Downs	Flat	Santa Fe	Yorkshire	Raised
	Essex	Raised	Sherwood		

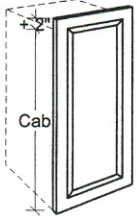
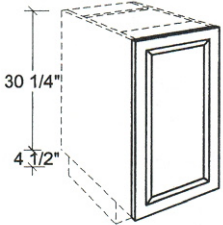
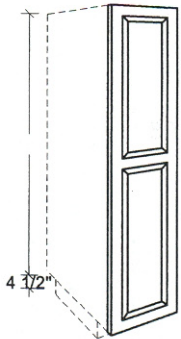

	<b>CODE</b>	<b>D</b>	<b>H</b>	<b>PRICE</b>
 <p>WALL BACK PANEL MATCH "A" Panels match group "A" Doors</p> <p>Specify Cabinet Size WBPMA is 2" Higher than Cabinet</p> <p>PRICE INCLUDES PLAIN SOLID WBP</p>	WBPMA			40 PER SQ. FT.
 <p>BASE BACK PANEL MATCH "A" Panels match group "A" Doors</p> <p>Add for Corbels</p> <p>Add Corbels after installation \$150</p> <ul style="list-style-type: none"> <li>•Price includes plain solid BBP</li> </ul> <p>Specify if BBPMA is to the floor</p>	BBPMA  CORBEL  BBPMAF			40 PER SQ. FT.  100  40 PER SQ. FT.
 <p>TALL BACK PANEL MATCH "A"</p> <p>Price includes plain solid TBP</p> <p>Specify if TBPMA is to the floor</p>	TBPMA  TBPMAF			40 PER SQ. FT.  40 PER SQ. FT.

<b>GROUP "A" DOORS</b>	Aladdin	Raised	Manhattan	True Raised	Raised
	Bead Board	No Frame	Oxford	Waterford	Raised
	Bradford	Flat	Oxford	Waterford	Flat
	Downs	Raised	Shaker	Windsor	Raised
	Downs	Flat	Santa Fe	Yorkshire	Raised
	Essex	Raised	Sherwood		

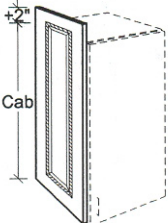
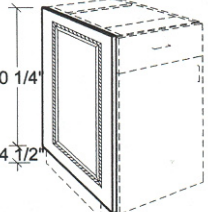
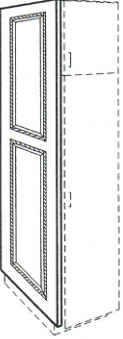
		CODE	D	H	PRICE
 <p>WALL END PANEL MATCH "B" Panels match group "B" Doors</p> <p>Specify Cabinet Size WEPMB is 1" Deeper and 2" Higher than Cabinet</p>		WEPMB1212 to WEPMB1236 WEPMB1237 to WEPMB1260	12 12	12 to 36 37 to 60	180 220
		WEPMB1812 to WEPMB1836 WEPMB1837 to WEPMB1860	18 18	12 to 36 37 to 60	200 240
		WEPMB2412 to WEPMB2436 WEPMB2437 to WEPMB2460	24 24	12 to 36 37 to 60	220 260
 <p>BASE END PANEL MATCH "B" Panels match group "B" Doors</p> <p>Specify Cabinet Size BEPMB is 1" Deeper than Cabinet</p> <p>•Price includes plain solid BEP</p> <p>Specify if BEPMA is to the floor</p>		BEPMB	24	25 to 36	240
		BEPMBF	24	25 to 36	240
 <p>TALL END PANEL MATCH "B"</p> <p>Specify Cabinet Size TEPMB is 1" Deeper than Cabinet</p> <p>Price includes plain solid TEP</p> <p>Specify if TEPMB is to the floor</p>		TEPMB384 to TEPMB1196 TEPMB1284 to TEPMB2496 TEPMB2584 to TEPMB3096	3 to 11 12 to 24 25 to 30	84 to 96 84 to 96 84 to 96	420 620 820
		TEPMB397 to TEPMB11108 TEPMB1297 - TEPMB24108 TEPMB2597 - TEPMB30108	3 to 11 12 to 24 25 to 30	97 - 108 97 - 108 97 - 108	520 720 920

<b>GROUP "B" DOORS</b>	Aladdin	Flat	New Yorker	Flat	Windsor	Flat
	Athena	Raised	Santa Fe	Flat	Yorkshire	Flat
	Barn		Shaker Bead	Flat		
	Bradford	Flat	Shaker Classic	Flat		
	Cambridge Center	Flat	Sherwood	Flat		
	Essex	Flat	St. Vincent	Flat		

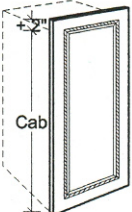
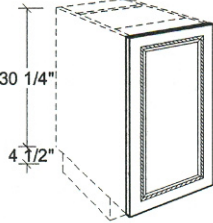
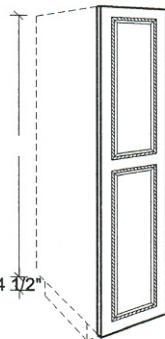
		<b>CODE</b>	<b>D</b>	<b>H</b>	<b>PRICE</b>
 <p><b>WALL BACK PANEL MATCH "B"</b> Panels match group "B" Doors</p> <p>Specify Cabinet Size WBPMB is 2" Higher than Cabinet</p> <p>PRICE INCLUDES PLAIN SOLID WBP</p>		WBPMB			50 PER SQ. FT.
 <p><b>BASE BACK PANEL MATCH "B"</b> Panels match group "B" Doors</p> <p>Add for Corbels</p> <p>Add Corbels after installation \$150</p> <ul style="list-style-type: none"> <li>•Price includes plain solid BBP</li> </ul> <p>Specify if BBPMB is to the floor</p>		BBPMB			50 PER SQ. FT.
		CORBEL			100
		BBPMBF			50 PER SQ. FT.
 <p><b>TALL BACK PANEL MATCH "B"</b></p> <p>Price includes plain solid TBP</p> <p>Specify if TBPMB is to the floor</p>		TBPMB			50 PER SQ. FT.
		TBPMBF			50 PER SQ. FT.

<b>GROUP "B" DOORS</b>	Aladdin	Flat	New Yorker	Flat	Windsor	Flat
	Athena	Raised	Santa Fe	Flat		
	Barn		Shaker Bead	Flat		
	Bradford	Flat	Shaker Classic	Flat		
	Cambridge Center	Flat	Sherwood	Flat		
	Essex	Flat	St. Vincent	Flat		

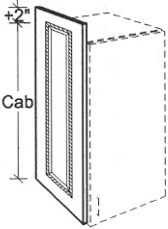
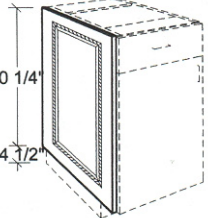
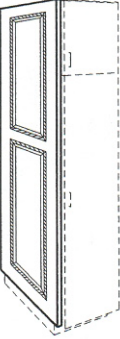
		CODE	D	H	PRICE
 <p>WALL END PANEL MATCH "C" Panels match group "C" Doors</p> <p>Specify Cabinet Size WEPMC is 1" Deeper and 2" Higher than Cabinet</p>		WEPMC1212 to WEPMC1236 WEPMC1237 to WEPMC1260	12 12	12 to 36 37 to 60	240 290
		WEPMC1812 to WEPMC1836 WEPMC1837 to WEPMC1860	18 18	12 to 36 37 to 60	260 310
		WEPMC2412 to WEPMC2436 WEPMC2437 to WEPMC2460	24 24	12 to 36 37 to 60	280 330
 <p>BASE END PANEL MATCH "C" Panels match group "C" Doors</p> <p>Specify Cabinet Size BEPMC is 1" Deeper than Cabinet</p> <p>•Price includes plain solid BEP</p> <p>Specify if BEPMC is to the floor</p>		BEPMC	24	25 to 36	300
		BEPMCF	24	25 to 36	300
 <p>TALL END PANEL MATCH "C"</p> <p>Specify Cabinet Size TEPMC is 1" Deeper than Cabinet</p> <p>Price includes plain solid TEP</p> <p>Specify if TEPMC is to the floor</p>		TEPMC384 to TEPMC1196 TEPMC1284 to TEPMC2496 TEPMC2584 to TEPMC3096	3 to 11 12 to 24 25 to 30	84 to 96 84 to 96 84 to 96	480 680 960
		TEPMC397 to TEPMC11108 TEPMC1297 - TEPMC24108 TEPMC2597 - TEPMC30108	3 to 11 12 to 24 25 to 30	97 - 108 97 - 108 97 - 108	580 780 1060

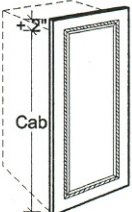
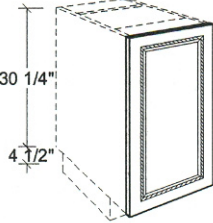
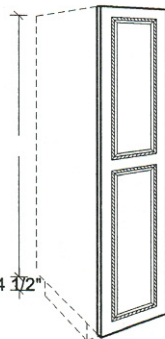

<b>GROUP "C" DOORS</b>	Athena	Flat	Sherwood Bead	Flat
	Canterbury	Flat	Stanford	Flat
	Cottage	Flat	Victorian	Raised
	Knottingham	Flat		
	New Castle	Flat		
	Rennissance	Flat		

	<b>CODE</b>	<b>D</b>	<b>H</b>	<b>PRICE</b>
 <p><b>WALL BACK PANEL MATCH "C"</b> Panels match group "C" Doors</p> <p>Specify Cabinet Size WBPMC is 2" Higher than Cabinet</p> <p>PRICE INCLUDES PLAIN SOLID WBP</p>	WBPMC			60 PER SQ. FT.
 <p><b>BASE BACK PANEL MATCH "C"</b> Panels match group "C" Doors</p> <p>Add for Corbels Add Corbels after installation \$150</p> <ul style="list-style-type: none"> <li>•Price includes plain solid BBP</li> </ul> <p>Specify if BBPMC is to the floor</p>	BBPMC  CORBEL  BBPMCF			60 PER SQ. FT.   60 PER SQ. FT.
 <p><b>TALL BACK PANEL MATCH "C"</b></p> <p>Price includes plain solid TBP</p> <p>Specify if TBPMC is to the floor</p>	TBPMC  TBPMCF			60 PER SQ. FT.  60 PER SQ. FT.

**GROUP "C" DOORS**

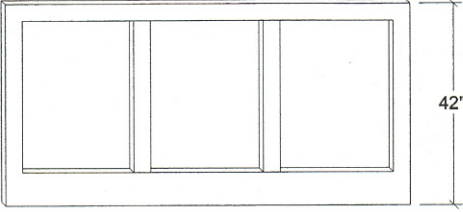
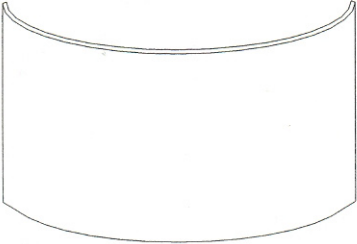
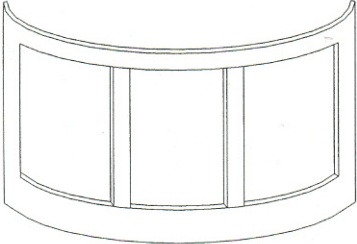
Athena	Flat	Sherwood Bead	Flat
Canterbury	Flat	Stanford	Flat
Cottage	Flat	Victorian	Raised
Knottingham	Flat		
New Castle	Flat		
Rennissance	Flat		

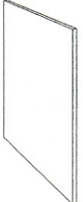
		<b>CODE</b>	<b>PRICE</b>
	<p><b>WAINSCOTING</b> Raised Panel</p>	<p>WAINMA WAINMB WAINMC</p>	<p>100 PER SQ. FT. 110 PER SQ. FT. 120 PER SQ. FT.</p>
	<p><b>WAINSCOTING</b> Bead Board</p>		
	<p>1-1/2" Bead Board 4" Bead Board</p>	<p>WAINSBB1 WAINSBB4</p>	<p>65 PER SQ. FT. 30 PER SQ. FT.</p>
	<p><b>CURVED BACK PANEL</b> Plain Panel</p>	<p>CBPPAIN</p>	<p>80 PER SQ. FT.</p>
	<p>1-1/2" Bead Board 4" Bead Board</p>	<p>CBBEAD1 CBBEAD4</p>	<p>120 PER SQ. FT. 145 PER SQ. FT.</p>
	<p><b>CURVED BACK PANEL</b> Raised Panel</p>	<p>CBPRPA CBPRPB CBPRPC</p>	<p>180 PER SQ. FT. 180 PER SQ. FT. 200 PER SQ. FT.</p>
	<p>Add \$400 for jig set up</p>		

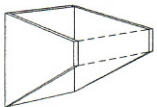
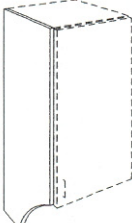
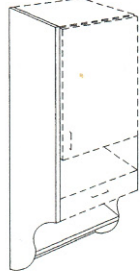
		<b>CODE</b>	<b>D</b>	<b>H</b>	<b>PRICE</b>
	<p>MELAMINE END PANEL</p> <ul style="list-style-type: none"> <li>•Melamine Panel with Edge</li> </ul>	MEP	24	25 to 36	50
	<p>DESK END PANEL</p> <ul style="list-style-type: none"> <li>•Veneer Panel with Edge Finished 2 Sides</li> </ul>	DSEP	24	25 to 36	120
	<p>DESK LEG PANEL</p> <ul style="list-style-type: none"> <li>•Veneer Panel with Edge Finished 2 Sides</li> </ul>	DLEP	24	25 to 36	195
	<p>DESK DRAWER KNEE SUPPORT</p> <ul style="list-style-type: none"> <li>•Finished both sides and face edges</li> </ul>	DKEP	21	25 to 36	250
	<p>HUTCH END PANEL</p> <ul style="list-style-type: none"> <li>•Veneer Panel with Edge</li> </ul>	HEP1212 to HEP1236 HEP1237 to HEP1260	12 12	12 to 36 37 to 60	120 180
	<p>HUTCH SCROLLED END PANEL</p> <ul style="list-style-type: none"> <li>•Solid Wood Panel</li> </ul>	HSEP1212 to HSEP1236 HSEP1237 to HSEP1260	12 12	12 to 36 37 to 60	175 240

PILASTER BOX REQUIRED  
For pilasters in these applications

Upper

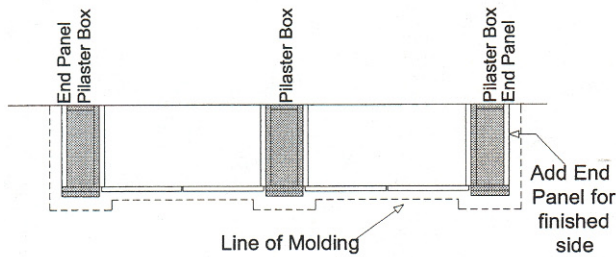

Base

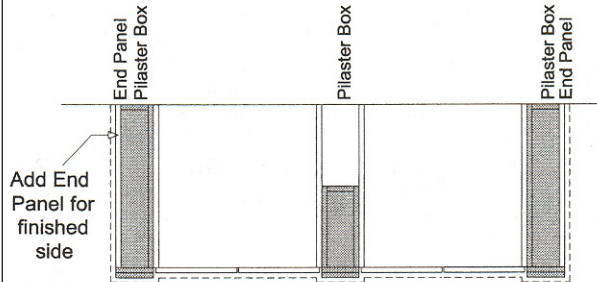

Crown Mold

Add \$15 per miter per molding

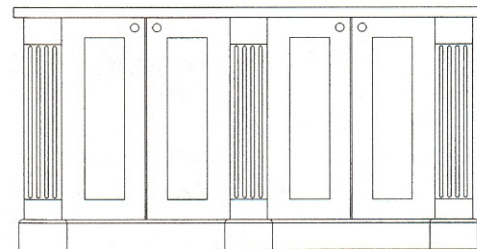
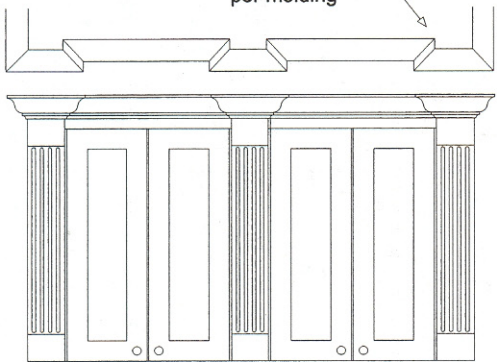

Base Mold

Add \$15 per miter per molding

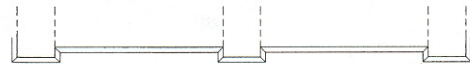

Crown Mold

Add \$15 per miter per molding

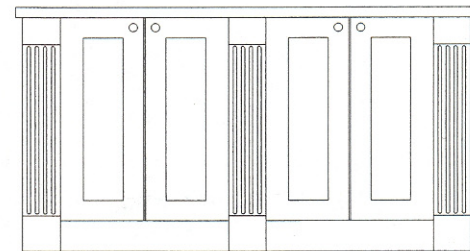
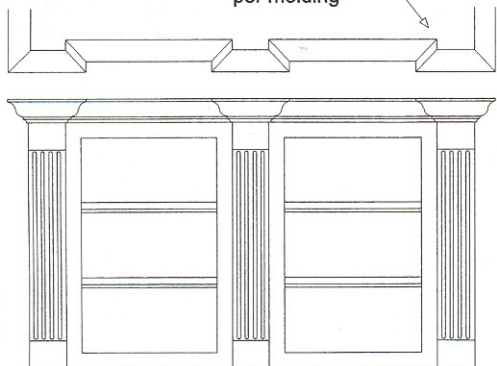

Recessed Toe Kick



Detail A

Detail B



	<b>CODE</b>	<b>D</b>	<b>H</b>	<b>PRICE</b>
<p><b>PILASTER</b>                      Regular                      Angled                      Add for miters                      PILASTER BOX INCLUDED                      SEE DETAIL A AND B                      36" Minimum Price</p>	PIL3BOX PIL6BOX  PILANG3BOX PILANG6BOX  MITER	3 3.5 - 6  3 3.5-6		115 PER FT. 140 PER FT.  140 PER FT. 170 PER FT.  15 PER CORNER PER MOLDING
<p><b>RIBBED PILASTER</b>                      Price as Fluted Pilaster                      Regular                      Angled                      Add for miters                      PILASTER BOX INCLUDED                      SEE DETAIL A AND B                      36" Minimum Price</p>	PIL3BOX  PILANG3BOX  MITER	3  3		115 PER FT.  140 PER FT.  15 PER CORNER PER MOLDING
<p><b>1/2 TURNED PILASTER</b>                      Regular                      Angled                      Add for miters                      PILASTER BOX INCLUDED                      SEE DETAIL A AND B                      36" Maximum Length                      36" Minimum Price</p>	PILHT3BOX  PILHTANG3BOX  MITER	3  3		135 PER FT.  165 PER FT.  15 PER CORNER PER MOLDING
<p><b>RADIUS CORNER</b>                      36" Minimum Price                      Pilaster Box Included</p>	RCBOX	3 to 6		150 PER FT.
<p><b>PILASTER BOX</b>                      Regular                      Angled                      36" Minimum Price</p>	PILBOX  PILBOXANG			75 PER FT.  100 PER FT.

PILASTER BOX NOT REQUIRED  
Pilaster with backer may be used ONLY as a  
filler or spacer

Upper



Line of Molding

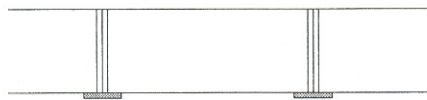
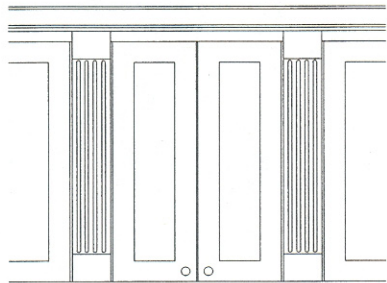

Line of Molding

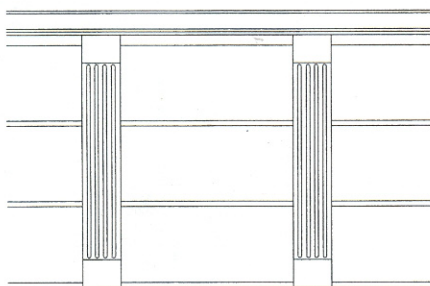

Detail C

Base

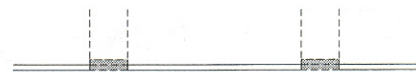
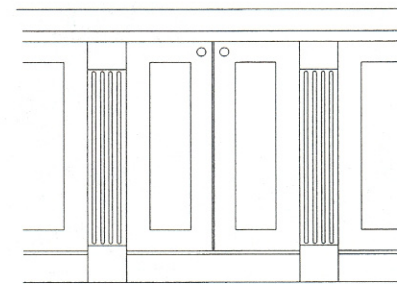
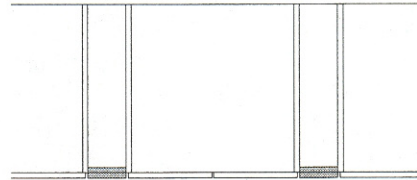

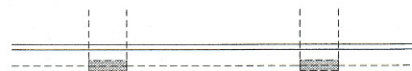
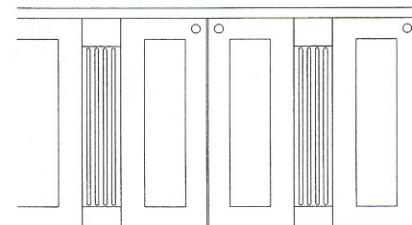

Base Mold  
Flush A or Flush C

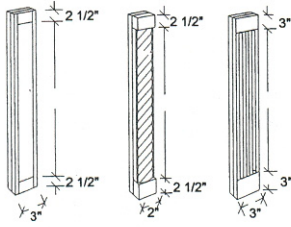
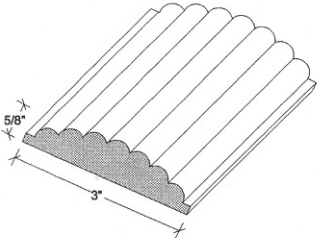

Recessed Toe Kick

Detail D

	CODE	D	H	PRICE
 <p><b>PILASTER</b> •Includes Backer</p> <p>Regular</p> <p>Angled</p> <p>Paneled    Rope    Fluted</p> <p><b>PILASTER WITH BACKER</b> MAY BE USED ONLY AS A FILLER OR SPACER. SEE DETAIL C AND D</p>	<p>PIL3 PIL6</p> <p>PILANG3 PILANG6</p>	<p>3 3.5 - 6</p> <p>3 3.5-6</p>		<p>45 PER FT. 75 PER FT.</p> <p>70 PER FT. 100 PER FT.</p>
 <p><b>RIBBED PILASTER</b> Price as Fluted Pilaster •Includes Backer</p> <p>Regular</p> <p>Angled</p> <p><b>PILASTER WITH BACKER</b> MAY BE USED ONLY AS A FILLER OR SPACER. SEE DETAIL C AND D</p>	<p>PIL3</p> <p>PILANG3</p>	<p>3</p> <p>3</p>		<p>45 PER FT.</p> <p>100 PER FT.</p>
 <p><b>1/2 PILASTER LEG</b></p> <p>Regular</p> <p>36" Maximum Length</p> <p><b>PILASTER WITH BACKER</b> MAY BE USED ONLY AS A FILLER OR SPACER. SEE DETAIL C AND D</p>	<p>PILLEG</p>	<p>3</p>		<p>250 PER SET</p>





# MOLDINGS



*Carriage House*  
*Fine Kitchen Cabinetry*

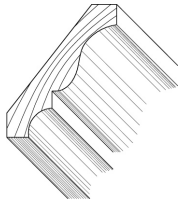
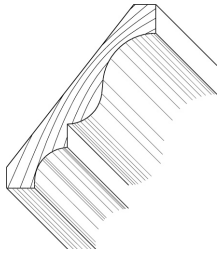
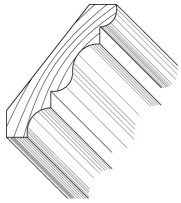
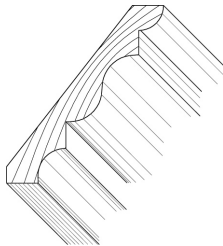

**MOLDINGS***Carriage House, Fine Kitchen Cabinetry***10.1**

		CODE	W	H	D	PRICE
	CROWN MOLD - <i>CM41</i> Crown and Sub	CM41S	4		$\frac{3}{4}$	40 PER FT.
	Crown Only	CM41				25 PER FT.
	Add for Miters AROUND PILASTERS AND BUMPS	MITER				15 PER CORNER PER MOLDING
	CROWN MOLD - <i>CM551</i> Crown and Sub	CM551S	$5\frac{1}{2}$		$\frac{13}{16}$	40 PER FT.
	Crown Only	CM551				25 PER FT.
	Add for Miters AROUND PILASTERS AND BUMPS	MITER				15 PER CORNER PER MOLDING
	CROWN MOLD - <i>CFS 4</i> Crown and Sub	CFS4S	4		$\frac{3}{4}$	50 PER FT.
	Crown Only	CFS4				30 PER FT.
	Add for Miters AROUND PILASTERS AND BUMPS	MITER				15 PER CORNER PER MOLDING
	CROWN MOLD - <i>CFS 6</i> Crown and Sub	CFS6S	$5\frac{1}{2}$		$\frac{13}{16}$	50 PER FT.
	Crown Only	CFS6				30 PER FT.
	Add for Miters AROUND PILASTERS AND BUMPS	MITER				15 PER CORNER PER MOLDING



**MOLDINGS**

*Carriage House, Fine Kitchen Cabinetry*

**10.2**

		CODE	W	H	D	PRICE
	CROWN MOLD - <i>CV6</i> Crown and Sub	CV6S		4	3/4	40 PER FT.
	Crown Only	CV6				25 PER FT.
	Add for Miters AROUND PILASTERS AND BUMPS	MITER				15 PER CORNER PER MOLDING
	CROWN MOLD - <i>CV8</i> Crown and Sub	CV8S		5	1	50 PER FT.
	Crown Only	CV8				30 PER FT.
	Add for Miters AROUND PILASTERS AND BUMPS	MITER				15 PER CORNER PER MOLDING
	CROWN MOLD - <i>CM 47</i> Crown and Sub	CM47S		4	3/4	40 PER FT.
	Crown Only	CM47				25 PER FT.
	Add for Miters AROUND PILASTERS AND BUMPS	MITER				15 PER CORNER PER MOLDING
	CROWN MOLD - <i>CM 57</i> Crown and Sub	CM57S		5	1	50 PER FT.
	Crown Only	CM57				30 PER FT.
	Add for Miters AROUND PILASTERS AND BUMPS	MITER				15 PER CORNER PER MOLDING

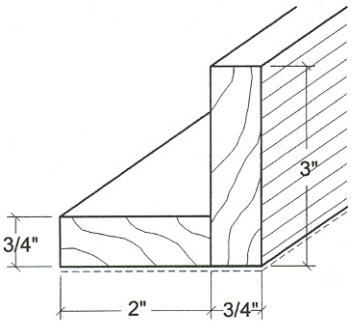
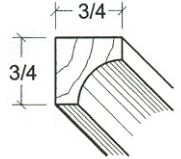
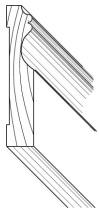

		<b>CODE</b>	<b>W</b>	<b>H</b>	<b>D</b>	<b>PRICE</b>
 <p><b>CROWN MOLD - <i>FLAT FC3</i></b> Crown and Sub</p> <p>Add for Miters AROUND PILASTERS AND BUMPS</p>		S15S	2 <sup>3/4</sup>	3	3/4	25 PER FT.
		MITER				15 PER CORNER PER MOLDING
 <p><b>COVE MOLD</b> Available in any size</p> <p>Up to 1"</p> <p>Up to 2"</p> <p>Any larger</p>		CV2				12 PER FT.
		CV3				18 PER FT.
						ASK GM FOR CUSTOM PRICING
 <p><b>BASE MOLD - <i>302</i></b></p> <p>Add for Miters AROUND PILASTERS AND BUMPS</p>		302	4	5/8		15 PER FT.
		MITER				15 PER CORNER PER MOLDING
 <p><b>BASE MOLD - <i>BASE 4</i></b></p> <p>Add for Miters AROUND PILASTERS AND BUMPS</p>		BASE4	5	5/8		20 PER FT.
		MITER				15 PER CORNER PER MOLDING

		CODE	W	H	D	PRICE	
	<p><b>SUB MOLD</b></p> <ul style="list-style-type: none"> <li>•2" Standard</li> <li>•includes sub cleat</li> <li>•3/8" radius</li> </ul> <p>3" Standard 4" Optional 6" Optional</p> <p>Add for other edges</p> <p>Add for Miters</p>	<p>SUB3</p> <p>SUB4</p> <p>SUB6</p> <p>SUBEDGE</p> <p>MITER</p>		<p>3</p> <p>4</p> <p>6</p>	<p>3/4</p> <p>3/4</p> <p>3/4</p>	<p>15 PER FT.</p> <p>20 PER FT.</p> <p>30 PER FT.</p> <p>10 PER FT.</p> <p>15 PER CORNER PER MOLDING</p>	
		<p><b>FACIA MOLD</b></p> <p><b>MATCHING EDGE OR 302</b></p> <p>Add for Miters</p>	<p>FACIA</p> <p>MITER</p>		<p>4</p>	<p>3/4</p>	<p>25 PER FT.</p> <p>15 PER CORNER PER MOLDING</p>
			<p><b>DENTAL MOLD</b></p> <p>1" x 1" Blocks</p> <p>1" x 1" Blocks with edge</p> <p>1" x 3" Blocks or other size <i>Special Dental by Bid Only</i></p> <p>Add for Miters</p>	<p>DENTAL1</p> <p>DENTAL2</p> <p>DENTAL4</p> <p>MITER</p>		<p>1</p> <p>1 3/4</p>	<p>3/4</p> <p>3/4</p>

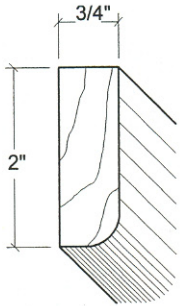
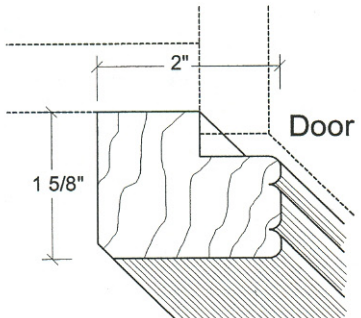
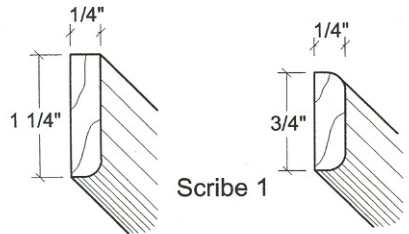
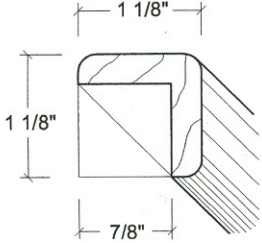
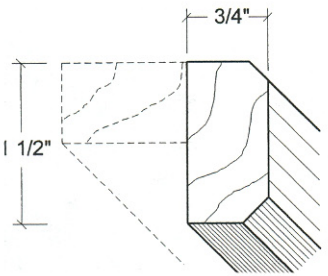
		CODE	W	H	D	PRICE
	<p><b>LIGHT RAIL</b></p> <ul style="list-style-type: none"> <li>•Includes Sub Cleat</li> <li>•<math>\frac{3}{8}</math>" Radius Edge</li> </ul> <p>Standard Light Rail</p> <p>For other edges</p> <p>Add for Miters</p>	LTR		2	$\frac{3}{4}$	15 PER FT.
		LTREDGE				25 PER FT.
		MITER				15 PER CORNER PER MOLDING
	<p><b>LIGHT RAIL MOLDING</b></p> <ul style="list-style-type: none"> <li>•Light Rail Flush with door</li> </ul> <p>Light Rail Molding</p> <p>Add for Miters</p> <p><i>Indicate edge</i></p>	LTRM		$1\frac{5}{8}$	2	25 PER FT.
		MITER				15 PER CORNER PER MOLDING
	<p><b>SCRIBE MOLD</b></p> <p>Scribe 2</p>	SCRIBE1		$1\frac{1}{4}$	$\frac{1}{4}$	10 PER FT.
		SCRIBE2		$\frac{3}{4}$	$\frac{1}{4}$	10 PER FT.
	<p><b>CORNER MOLD</b></p>	CORNER		$1\frac{1}{8}$	$1\frac{1}{8}$	15 PER FT.
	<p><b>COUNTER/DECK TRIM</b></p>	DECK		$1\frac{1}{2}$	$\frac{3}{4}$	15 PER FT.

**MOLDINGS**

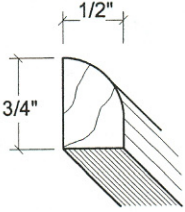
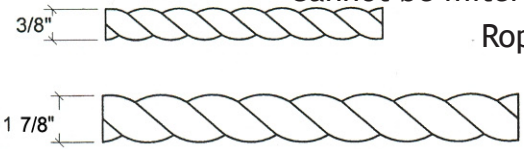
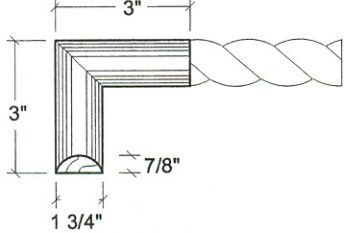
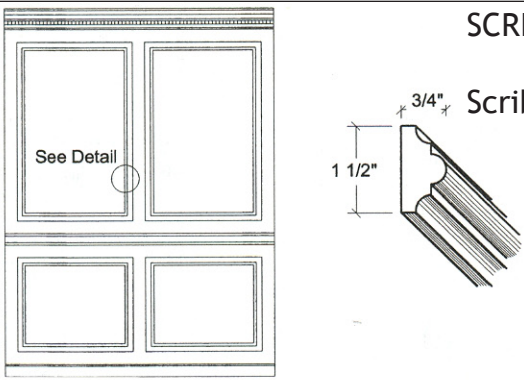
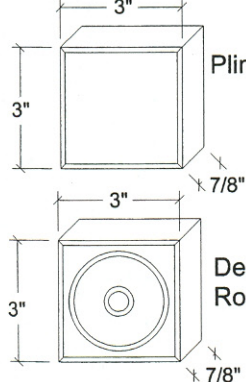
	<b>CODE</b>	<b>W</b>	<b>H</b>	<b>D</b>	<b>PRICE</b>
 <p><b>QUARTER MOLD</b></p>	QUARTER		3/4	1/2	10 PER FT.
 <p><b>ROPE MOLD</b> Available only Maple and Alder Cannot be mitered</p> <p>Rope 1</p> <p>Rope 2</p>	ROPE1 ROPE2 ROPE3 ROPE4 OTHER WOOD SPECIES		3/8 1/2 3/4 1 7/8		10 PER FT. 20 PER FT. 30 PER FT. 50 PER FT. ASK GM FOR CUSTOM PRICEV
 <p><b>TERMINATION BLOCK</b></p>	TCB	3	3	7/8	50
 <p><b>SCRIBE MOLD</b></p> <p>Scribe 2</p>	PLANT MITER		1 1/2 3/4		12 PER FT. 15 PER CORNER PER MOLDING
 <p><b>BLOCKS</b></p> <p>Plinth Block</p> <p>Decorative Block Rosette</p>	PLH RST	3 3	3 3	7/8 7/8	20 40

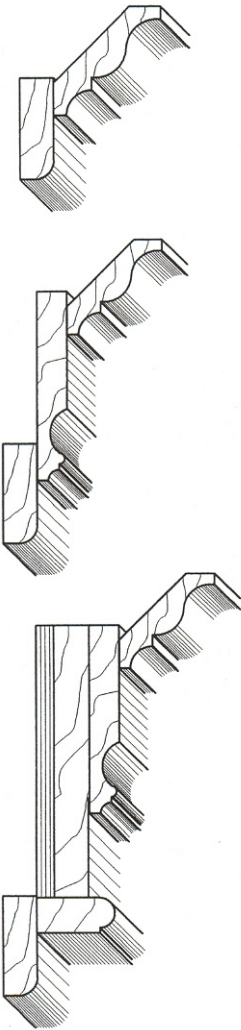
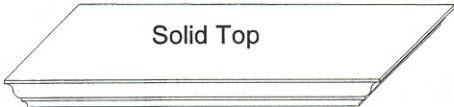
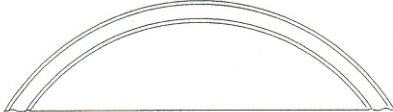
		CODE	W	H	D	PRICE
	<p><b>BUILT-UP CROWN MOLD</b></p> <ul style="list-style-type: none"> <li>•Standard Molding</li> <li>•Standard Crowns and Sub Mold</li> </ul>					
	<p><b>Facia 302 Molding</b></p> <ul style="list-style-type: none"> <li>•Standard Crown, Facia, and Sub Mold</li> </ul>					
	<p><b>Built-up Molding</b></p> <ul style="list-style-type: none"> <li>•More than 3 moldings in combinations</li> <li>•Detail all built-up moldings at actual size</li> </ul> <p>Add for miters</p>					
		MITER				<p>Add 50% to each additional molding plus cost of molding</p> <p>15 PER CORNER PER MOLDING</p>
 <p>Solid Top</p>	<p><b>CROWN PEDIMENT</b></p> <ul style="list-style-type: none"> <li>•For Free Standing Unit</li> <li>•4"-6" high</li> </ul>	PEDCWN		4-6		60 PER SQ. FT.
	<p><b>ARCHED PEDIMENT</b></p>	PEDARCH				525 PER RUNNING FT.

**MOLDINGS**

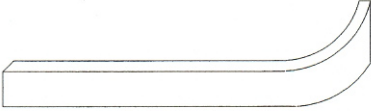
	CODE	W	H	D	PRICE
 <p><b>RADIUS SUB MOLD</b> •Made in one piece</p>	SUBRAD		2	<sup>3</sup> / <sub>4</sub>	30 PER FT. PLUS 150 PER RADIUS
 <p><b>RADIUS LIGHT RAIL</b> •Made in one piece</p>	LTRRAD		2	<sup>3</sup> / <sub>4</sub>	30 PER FT. PLUS 150 PER RADIUS
<p>RAYMOND ENKEBOLL MOLDINGS Price from special list</p> <p>Add for miters</p>	MITER				<i>see Enkeboll price list</i>  50 PER CORNER
<p><b>MOLDING SET-UP FEES</b> •Wood species that are not a stock item will be charged a setup fee. •Moldings not in book will be charged a set up fee</p>	SETUP				250
<p><b>MOLDING FINISHING</b> •Additional Moldings/Handrails •Spindles •Raymond Enkeboll Carvings</p>	FINMOLD FINSPINDLE FINCARVE				12 PER FT. 25 PER FT. 50 PER FT.



*Carriage House*  
*Fine Kitchen Cabinetry*



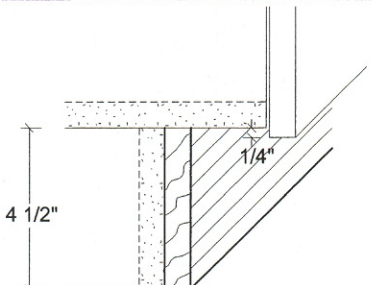
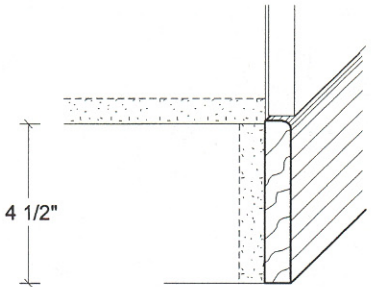
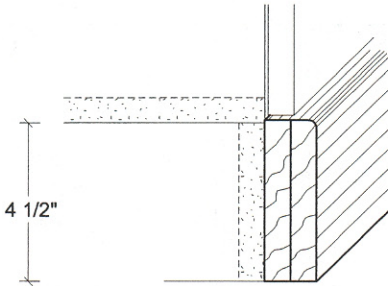
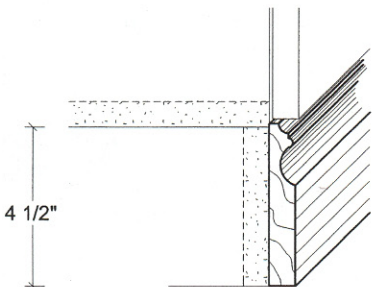
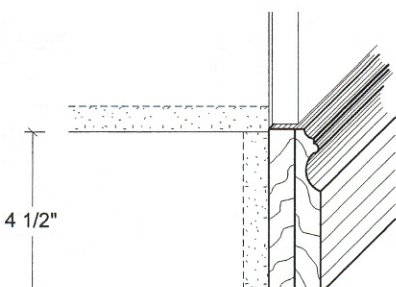

**TOE KICKS**

		CODE	W	H	D	PRICE
 <p>4 1/2"</p> <p>1/4"</p>	<p>- STANDARD • No Charge</p>			5 3/4		No Charge
 <p>4 1/2"</p>	<p>Flush A • Matching Edge Of Door</p>	FLUSHA		5 3/4		18 PER FT.
 <p>4 1/2"</p>	<p>Flush B • Matching Edge Of Door  - includes toe backer</p>	FLUSHB		5 3/4		30 PER FT.
 <p>4 1/2"</p>	<p>Flush C • Matching Edge with 302 or Base 4</p>	FLUSHC		5 3/4		30 PER FT.
 <p>4 1/2"</p>	<p>Flush D • Matching Edge with 302 or Base 4  - includes toe backer</p>	FLUSHD		5 3/4		40 PER FT.

**TOE KICKS**

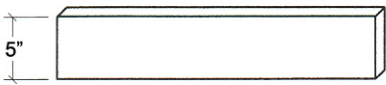
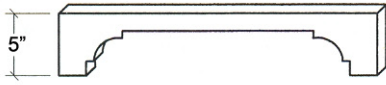
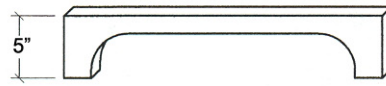
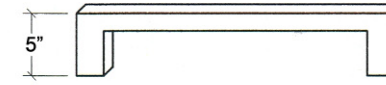
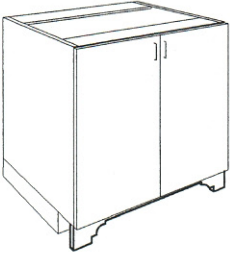
		CODE	W	H	D	PRICE
 <p>STANDARD</p> <ul style="list-style-type: none"> <li>•Included in cabinet price</li> <li>•Additional 4 1/2" Toe Kick</li> <li>•Other Sizes</li> </ul>	<p>TK</p> <p>TKOTHER</p>	5	3/4	14 PER LINEAR FT. <p>50 PER LINEAR FT.</p>		
 <p>BASE VALANCE A</p>	BVA	5	3/4	125 PER LINEAR FT.		
 <p>BASE VALANCE B</p>	BVB	5	3/4	125 PER LINEAR FT.		
 <p>BASE VALANCE C</p>	BVC	5	3/4	125 PER LINEAR FT.		
 <p>Base Valance is applied flush with front of case</p>						

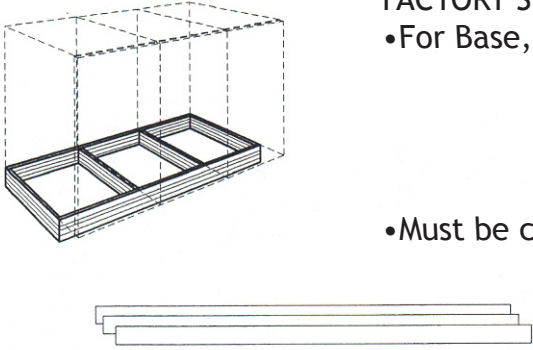
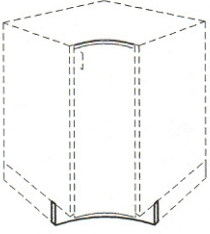
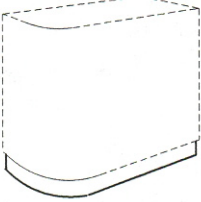
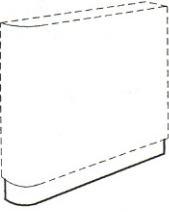
		CODE	W	H	D	PRICE
 <p><b>FACTORY SUPPLIED TOE BOX</b>                      •For Base, Utility, &amp; Vanity</p> <p>•Must be cut to size on site</p>		TKBOX	4 1/2	3/4		50 PER FT.
 <p><b>TOE KICK CORNER</b></p> <p>•Inside Radius</p> <p>•Included with Cabinet</p>		TKRADINS	4 1/2	3/4		200 PER CORNER
 <p><b>TOE KICK COVER</b></p> <p>•Outside Radius</p> <p>•Included with Cabinet</p>		TKRADOUT	4 1/2	3/4		200 PER CORNER
 <p><b>TOE KICK COVER</b></p> <p>•Outside Radius 3"</p> <p>•Included with Cabinet</p>		TKRADOUT3	4 1/2	3/4		150 PER CORNER





**LEGS**



*Carriage House*  
*Fine Kitchen Cabinetry*



**LEGS**

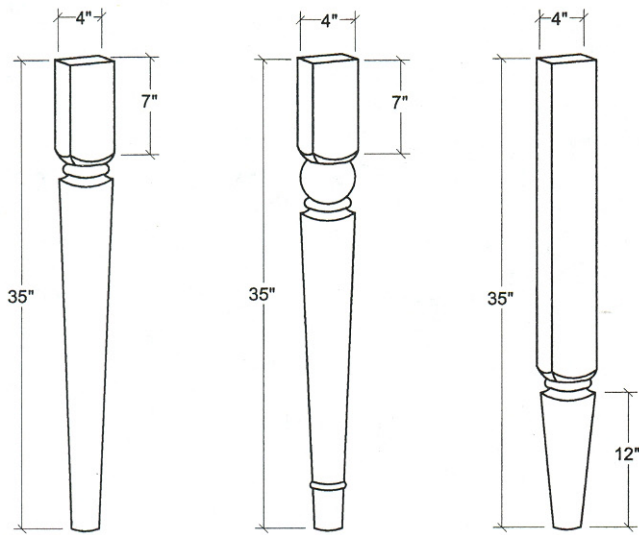

**LEG 45**

**LEG 46**

**LEG 35**

**NO BOTTOM SHELF**

CODE	W	H	D	PRICE
------	---	---	---	-------

LEG453	3	35	3	400
LEG454	4	35	4	400
LEG455	5	35	5	450
LEG456	6	35	6	500
LEG463	3	35	3	400
LEG464	4	35	4	400
LEG465	5	35	5	450
LEG466	6	35	6	500
LEG353	3	35	3	400
LEG354	4	35	4	400
LEG355	5	35	5	450
LEG356	6	35	6	500

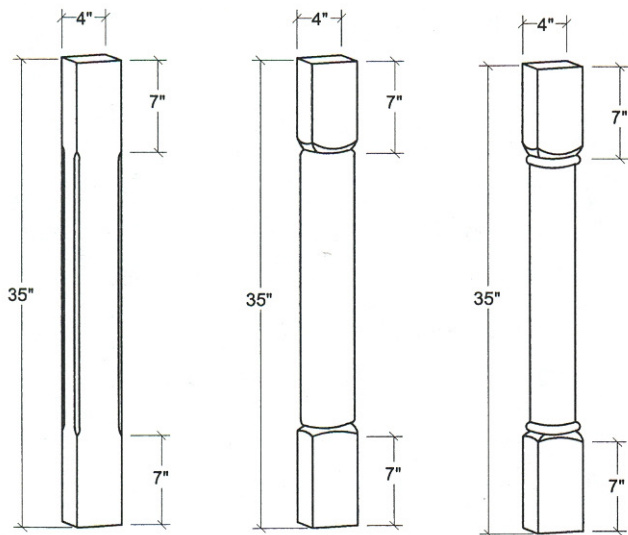

**LEG 60**

**LEG 85**

**LEG 70**

LEG603	3	35	3	200
LEG604	4	35	4	200
LEG605	5	35	5	250
LEG606	6	35	6	300
LEG853	3	35	3	400
LEG854	4	35	4	400
LEG855	5	35	5	450
LEG856	6	35	6	500
LEG703	3	35	3	400
LEG704	4	35	4	400
LEG705	5	35	5	450
LEG706	6	35	6	500

For custom sizes add 15% to the price of the nearest size, oversized legs are custom priced.

**LEGS**

*Carriage House, Fine Kitchen Cabinetry*

**12.2**



				CODE	W	H	D	PRICE
<p>LEG 55      LEG 20      LEG 22</p>	LEG553	3	35	3	400			
	LEG554	4	35	4	400			
	LEG555	5	35	5	450			
	LEG556	6	35	6	500			
	LEG203	3	35	3	400			
	LEG204	4	35	4	400			
	LEG205	5	35	5	450			
	LEG206	6	35	6	500			
	LEG223	3	35	3	400			
	LEG224	4	35	4	400			
	LEG225	5	35	5	450			
	LEG226	6	35	6	500			
	<p>LEG 21      LEG 23      ROPELEG      BEADLEG</p>	LEG213	3	35	3	400		
LEG214		4	35	4	400			
LEG215		5	35	5	450			
LEG216		6	35	6	500			
LEG233		3	35	3	400			
LEG234		4	35	4	400			
LEG235		5	35	5	450			
LEG236		6	35	6	500			
ROPELEG3		3	35	3	500			
ROPELEG4		4	35	4	550			
ROPELEG5		5	35	5	600			
ROPELEG6		6	35	6	650			
BEADLEG3		3	35	3	500			
BEADLEG4		4	35	4	550			
BEADLEG5		5	35	5	600			
BEADLEG6		6	35	6	650			

For custom sizes add 15% to the price of the nearest size, oversized legs are custom priced.

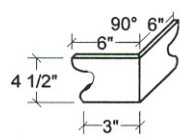
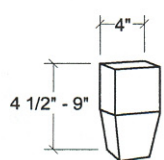
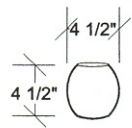
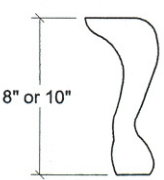
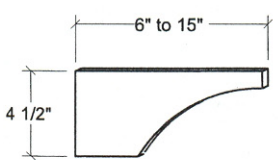
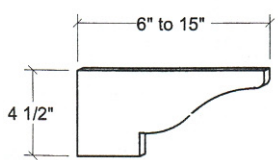

	<b>CODE</b>	<b>W</b>	<b>H</b>	<b>D</b>	<b>PRICE</b>
 <p><b>1/2 PILASTER LEG</b></p> <ul style="list-style-type: none"> <li>•Maximum 36"</li> <li>•Custom Turning</li> <li>•Includes 3/4" back panel</li> </ul>	PILLEG	3	35		250
 <p><b>FOOT 8</b></p> <ul style="list-style-type: none"> <li>•Hutch Leg</li> <li>•Other Angles add 30%</li> </ul>	FOOT8	6	4 1/2	6	250
 <p><b>FOOT 11</b></p> <p>Add for trim</p>	FOOT11	4	4 1/2 to 9	4	150  50
 <p><b>FOOT 12</b></p> <ul style="list-style-type: none"> <li>•To be installed as full round</li> </ul>	FOOT12	4 1/2	4 1/2	4 1/2	150
 <p><b>FOOT 13 - QUEEN ANNE</b></p> <ul style="list-style-type: none"> <li>•Available in Maple, Cherry, Oak, and Mahogany</li> <li>•NO BASE VALANCE</li> </ul>	FOOT13		8 & 10		150
 <p><b>FOOT 14</b></p>	FOOT14 FOOT14	6-11 12-15	4 1/2 4 1/2	3/4 3/4	125 150
 <p><b>FOOT 15</b></p>	FOOT15 FOOT15	6-11 12-15	4 1/2 4 1/2	3/4 3/4	125 150

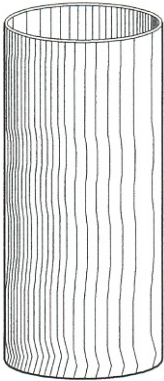
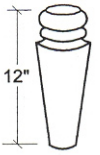
**LEGS**

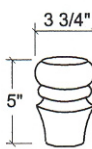
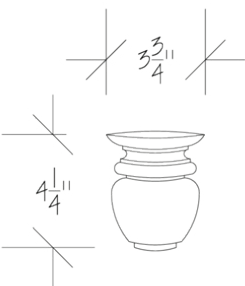
		CODE	W	H	D	PRICE
	<p><b>ONE PIECE PLYWOOD CYLINDERS</b></p> <p>Wood Veneer</p> <p>Metal Laminate</p>	PC16	12-16			280
		PC24	18-24			380
		PC36	25-36			850
		PCWV				600
		PCML				600
 <p>12"</p>	FOOT10	12			200	
	FOOT16	5 1/2	5	5 1/2	150	
	FOOT17	3 3/4	5	3 3/4	150	
	FOOT18	3 3/4	4 1/4	3 3/4	150	
 <p>5 1/2"</p> <p>5"</p>	FOOT 16					
 <p>3 3/4"</p> <p>5"</p>	FOOT 17					
 <p>3 3/4"</p> <p>4 1/4"</p>	FOOT 18					

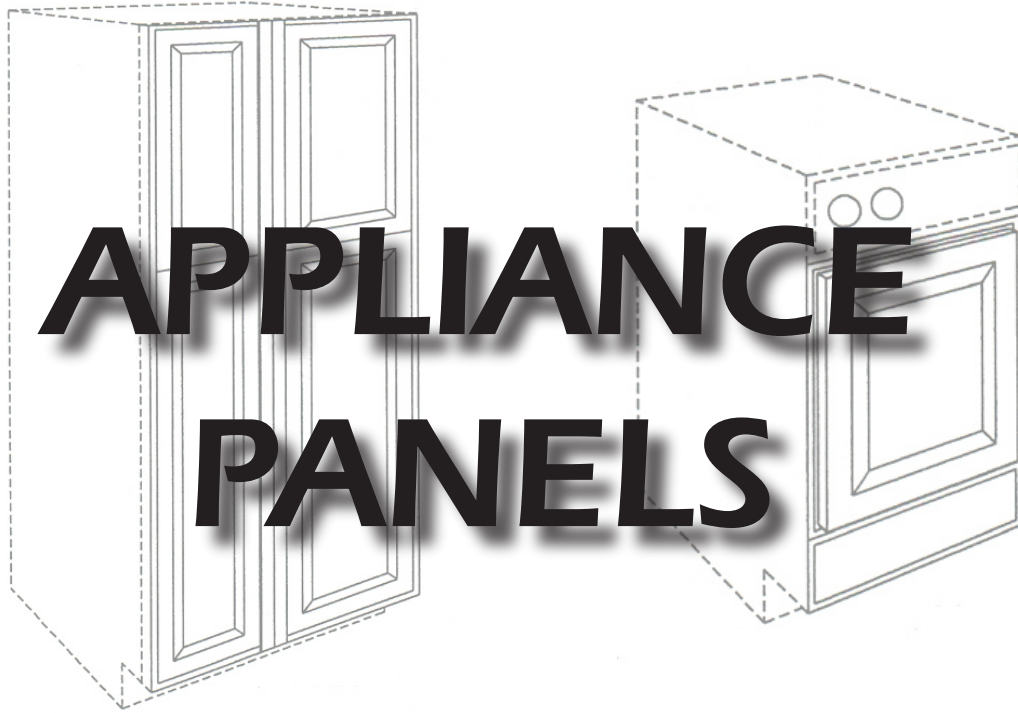





# APPLIANCE PANELS



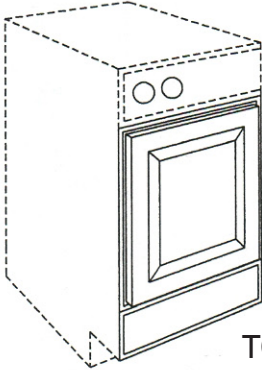
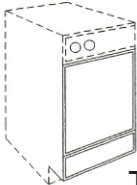
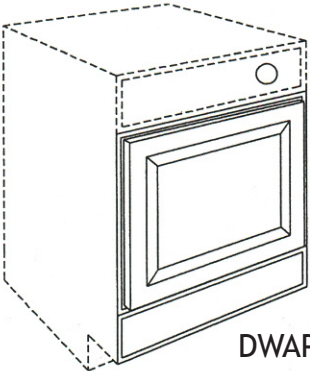
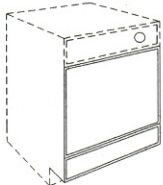
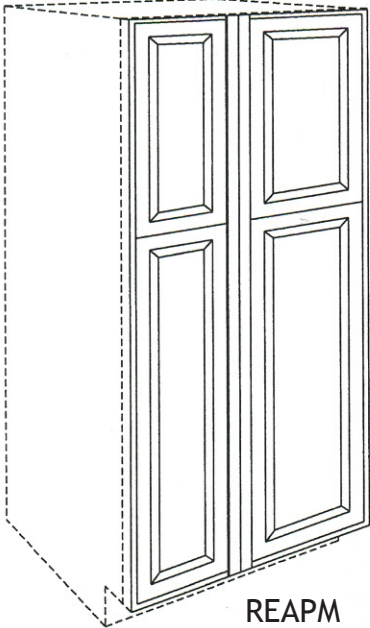
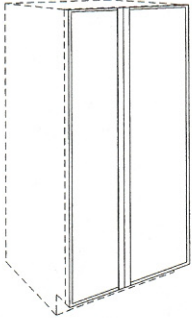

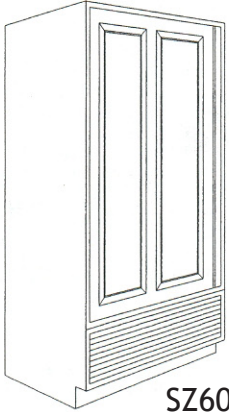
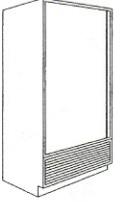
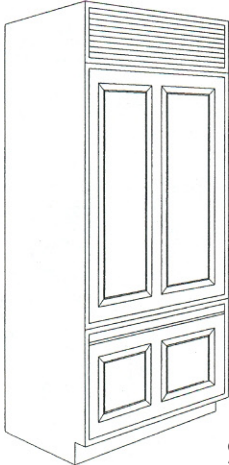

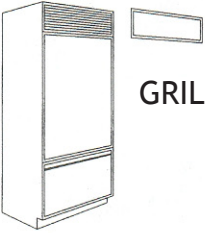
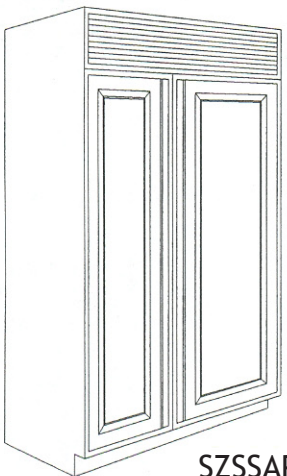
*Carriage House*  
*Fine Kitchen Cabinetry*

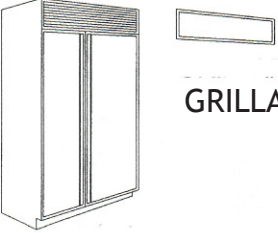

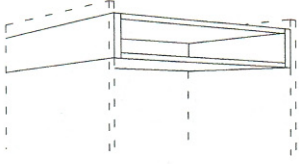
			<b>CODE</b>	<b>PRICE</b>
 <p>TCAPM</p>	<p><b>TRASH COMPACTOR</b> •Appliance Trim</p>  <p>TCAP</p>	1/4" Panel Only	TCAP	380
		Raised Panel Includes 1/4" Panel	TCAPM	380 plus 1 Door per Panel
 <p>DWAPM</p>	<p><b>DISH WASHER</b> •Appliance Trim</p>  <p>DWAP</p>	1/4" Panel Only	DWAP	380
		Raised Panel Includes 1/4" Panel	DWAPM	380 plus 1 Door per Panel
 <p>REAPM</p>	<p><b>REFRIGERATOR</b> •Appliance Trim</p>  <p>REAP</p>	1/4" Panel Only	REAP	650
		Raised Panel Includes 1/4" Panel	REAPM	860 plus 1 Door per Panel

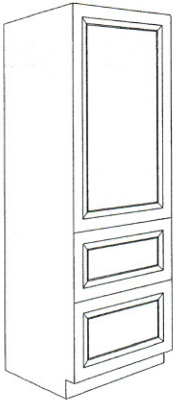
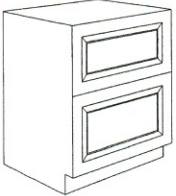
			<b>CODE</b>	<b>PRICE</b>
 <p>SZ601APM</p>	<p><b>SUB-ZERO MODEL 601</b> •Appliance Trim</p>  <p>SZ601AP</p>	1/4" Panel Only	SZ601AP	450
		Raised Panel Includes 1/4" Panel	SZ601APM	760 plus 1 Door per Panel
 <p>SZOUAPM</p>	<p><b>SUB ZERO OVER/UNDER</b> •Appliance Trim</p>  <p>GRILLAPM</p>  <p>GRILLAP</p>	1/4" Panel Only	SZOUAP	650
		Raised Panel Includes 1/4" Panel	SZOUAPM	860 plus 1 Door per Panel
		GRILL PANEL TRIM 1/4" Panel Only	GRILLAP	150
		Raised Panel Includes 1/4" Panel	GRILLAPM	150 plus 1 Door per Panel
 <p>SZSSAPM</p>	<p><b>SUB ZERO SIDE BY SIDE</b> •Appliance Trim</p>  <p>GRILLAPM</p>  <p>GRILLAP</p>	1/4" Panel Only	SZSSAP	650
		Raised Panel Includes 1/4" Panel	SZSSAPM	860 plus 1 Door per Panel
		GRILL PANEL TRIM 1/4" Panel Only	GRILLAP	150
		Raised Panel Includes 1/4" Panel	GRILLAPM	150 plus 1 Door per Panel

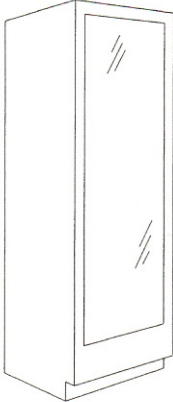
		CODE	PRICE
	<p><b>SUB-ZERO PANEL BOX</b></p> <p>36" to 48" Wide</p> <p>Add for false door Add for Hinges</p>	<p>SZPB</p>	<p>125</p> <p>100</p>
 <p>SZ601APM      SZ601AP</p>	<p><b>SUB ZERO SERIES 200</b></p> <p>•Appliance Trim</p> <p>1/4" Panel Only</p> <p>Raised Panel Includes 1/4" Panel</p>	<p>SZ00AP</p> <p>SZ200APM</p>	<p>100</p> <p>200 plus 1 Door per Panel</p>
 <p>SZ700APM</p>	<p><b>SUB ZERO SERIES 700</b></p> <p>•Appliance Trim</p> <p>Raised Panel</p>	<p>SZ700APM</p>	<p>960 plus 1 Door per Panel</p>
 <p>SZDRAPM</p>	<p><b>SUB ZERO DRAWERS</b></p> <p>•Appliance Trim</p> <p>Raised Panel</p>	<p>SZDRAPM</p>	<p>350 plus 1 Door per Panel</p>

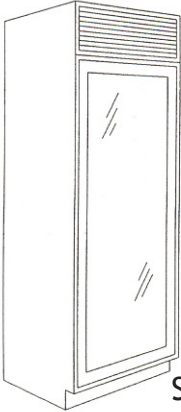
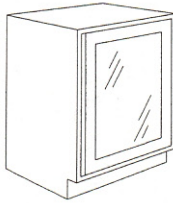
			CODE	PRICE
 <p>SZ601APM</p>	<p>SUB-ZERO MODEL 427</p> <ul style="list-style-type: none"> <li>•Wine Storage</li> <li>•Appliance Trim</li> </ul>	<p>Frame Only</p>	<p>SZ427APM</p>	<p>380 Add for special door</p>
 <p>SZ427RAPM</p>	<p>SUB ZERO SERIES 427R</p> <ul style="list-style-type: none"> <li>•Wine Storage/Refrigerator</li> <li>•Appliance Trim</li> </ul>	<p>Frame Only on Wine Storage</p>	<p>SZ427RAPM</p>	<p>660 plus 1 Door per Panel</p>
 <p>SZ430APM</p>	<p>SUB ZERO MODEL 430</p> <ul style="list-style-type: none"> <li>•Wine Storage</li> <li>•Appliance Trim</li> </ul>	<p>Frame Only</p>	<p>SZ430APM</p>	<p>350 Add for special door</p>
 <p>SZ424APM</p>	<p>SUB ZERO MODEL 424</p> <ul style="list-style-type: none"> <li>•Wine Storage</li> <li>•Appliance Trim</li> </ul>	<p>Frame Only</p>	<p>SZ424APM</p>	<p>250 plus 1 Door per Panel</p>





*Carriage House*  
*Fine Kitchen Cabinetry*

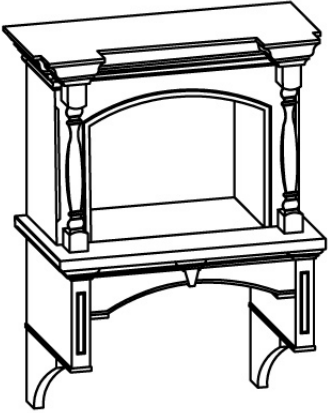
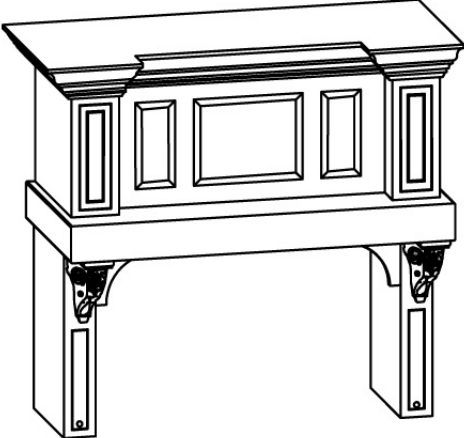
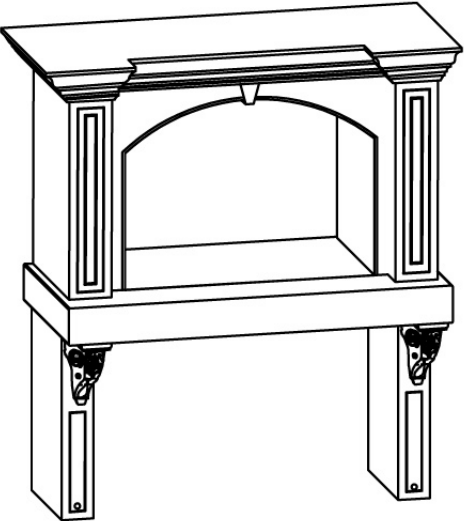

		CODE	PRICE
	HOOD A	HOODA36	5660
	Includes	HOODA48	6604
	•legs, valences, etc.	HOODA60	7547
	Does Not Include	HOODA72	9057
•corbels			
	HOOD B	HOODB36	3774
	Includes	HOODB48	4717
	•crown, inner corbels, etc.	HOODB60	5660
	Does Not Include	HOODB72	6981
•Enkeboll corbels			
•spice pull-outs			
	HOOD C	HOODC36	4151
	Includes	HOODC48	5094
	•crown, valance, etc.	HOODC60	6038
	Does Not Include	HOODC72	7358
•Enkeboll corbels			
•spice pull-outs			

For other designs get price and approval from the General Manager or Assistant General Manager  
Add for any accessories, see also accessories in Hoods section.

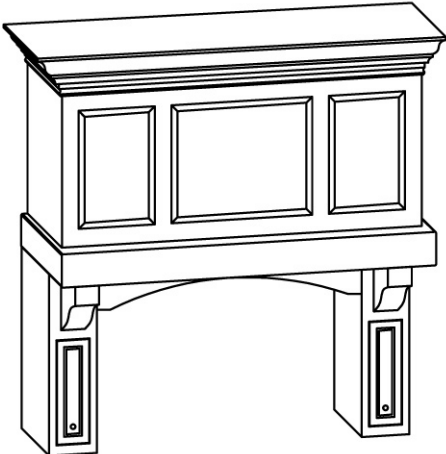
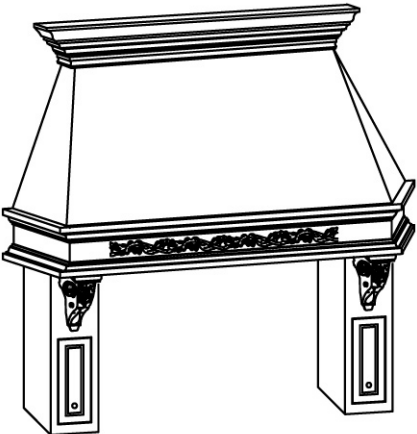
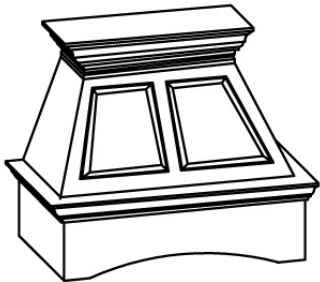
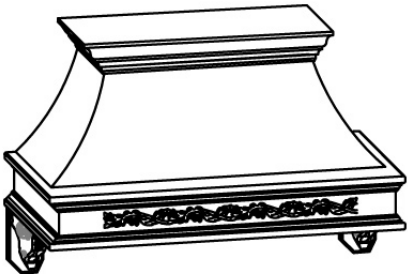
		CODE	PRICE
	HOOD D	HOODD36	3585
	Includes	HOODD48	4528
	•corbels, valence, etc.	HOODD60	5472
	Does Not Include	HOODD72	6792
	•spice pull-outs		
	HOOD E	HOODE36	4151
	Includes	HOODE48	5094
	•crown, upper section, etc.	HOODE60	6038
	Does Not Include	HOODE72	7358
	•Enkeboll corbels, onlay		
	•spice pull-outs		
	HOOD F	HOODF36	3019
	Includes	HOODF48	3692
	•everything shown	HOODF60	4906
		HOODF72	5849
	HOOD G	HOODG36	4191
	Does Not Include	HOODG48	5094
	•Enkeboll corbels, onlay	HOODG60	6792
		HOODG72	8302

For other designs get price and approval from the General Manager or Assistant General Manager

Add for any accessories, see also accessories in Hoods section.

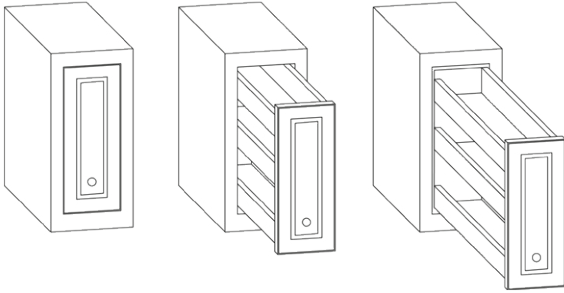
		CODE	PRICE
 <p><b>SPICE PULL-OUT</b></p> <ul style="list-style-type: none"> <li>•Includes finished box</li> <li>•Add for door</li> </ul>	SPO	755	
	<ul style="list-style-type: none"> <li>•Add for Enkeboll items</li> <li>•Add for special valence</li> <li>•Add for custom arched doors</li> <li>•Add for extra moldings</li> </ul>	AD31 AD32 AD33	SEE ENKEBOLL CATALOG TALK TO GM or Asistant GM 290 180 290 SEE MOLDINGS SECTION



# MANTELS



*Carriage House*  
*Fine Kitchen Cabinetry*





MANTELS

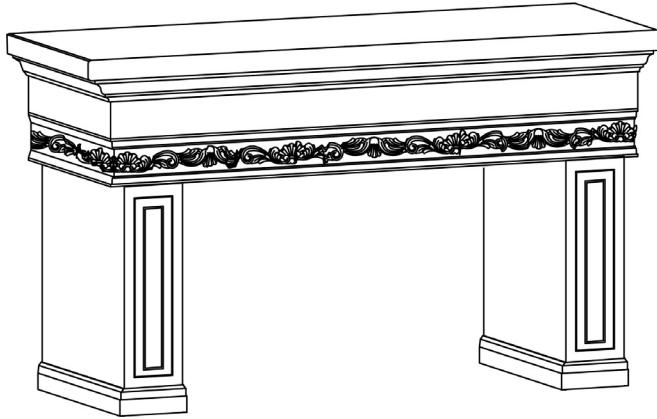

- 3" Deck
- Add for trim
- Add Crown Mold
- Facia 5" to 8" High
- 9" to 12" High
- Add for Extra Moldings
- Face of Leg
- Leg Returns
- Base Mold
- AS SHOWN

CODE	PRICE
MANTELDECK	160 PER SQ. FT.
	Book Price
FACIAM8	30 PER LINEAL FT.
FACIAM12	50 PER LINEAL FT.
	Book Price
MLEGMA	360
MLEGMB	480
MLEGMC	600
MLEG	200
	Book Price
	3545

NOTE: All Mantels must be on a separate bid sheet

**MANTEL FINISHING ONLY**

•Your mantel provided to Carriage House PRE-SANDED and READY to stain. Extra Charge for Prep Work.

SPRAYMAN	35 PER SQ. FT.
----------	----------------

**ALL CUSTOM MANTELS MUST BE SUBMITTED TO THE GENERAL MANAGER OR ASSISTANT GENERAL MANAGER FOR CUSTOM PRICING.**

**CARRIAGE HOUSE MANTEL**

- ENKEBOLL CORBELS AND ONLAYS NOT INCLUDED IN PRICE



UP TO 7' WIDE

UPPER SECTION ONLY

BASE SECTION ONLY

ENKEBOLL CORBELS  
AND ONLAYS

**CODE**

**PRICE**

CHCMANTEL

13500

CHCMANTELU

9000

CHCMANTELB

5000

SEE  
ENKEBOLL  
PRCING

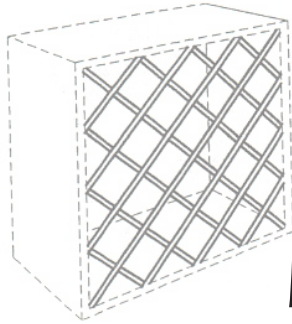

# PARTS

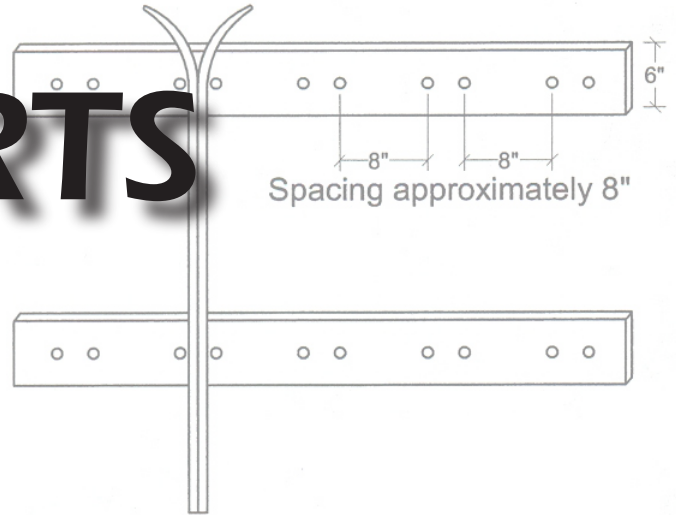

*Carriage House*  
*Fine Kitchen Cabinetry*

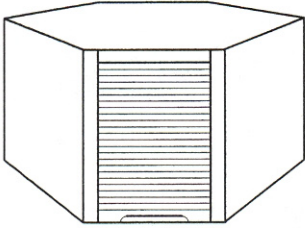
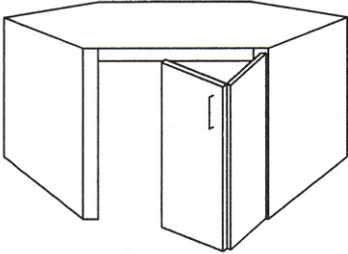
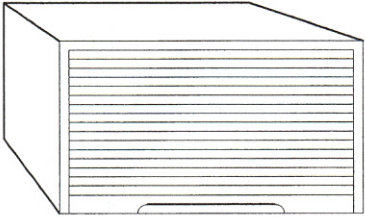
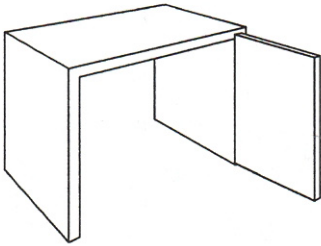
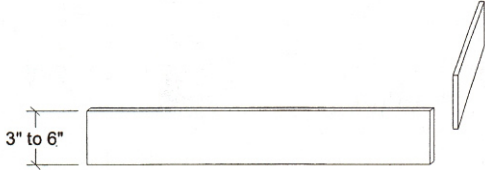

		<b>CODE</b>	<b>PRICE</b>
	<p><b>APPLIANCE CENTER</b></p> <ul style="list-style-type: none"> <li>•45° Corner</li> <li>•Tambour Door</li> </ul>	AC	700
	<p><b>APPLIANCE CENTER CORNER BI-FOLD</b></p> <ul style="list-style-type: none"> <li>•45° Corner</li> <li>•Bi-Fold Door</li> </ul>	ACCBF	550 plus 2 doors
	<p><b>APPLIANCE CENTER SQUARE</b></p> <ul style="list-style-type: none"> <li>•Tambour Door</li> </ul> <p>Up to 24" Wide</p> <p>Add for over 24" wide per additional foot</p>	ACSQ	600  100 PER FT.
	<p><b>APPLIANCE CENTER DOOR</b></p> <ul style="list-style-type: none"> <li>•Square Appliance Center</li> <li>•Single Door</li> </ul> <p>Specify Left or Right Door</p>	ACD	150 PER FT. PLUS DOOR
	<p><b>TABLE APRON</b></p> <ul style="list-style-type: none"> <li>•Solid Wood</li> </ul>	APRONT	25 PER FT.

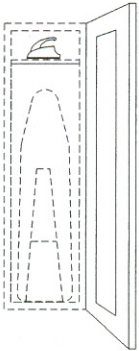
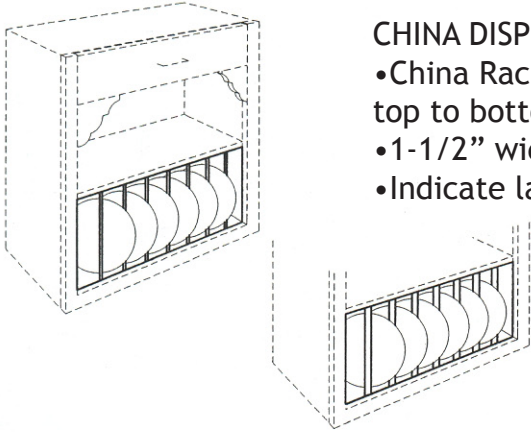
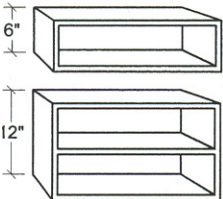
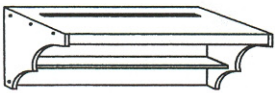
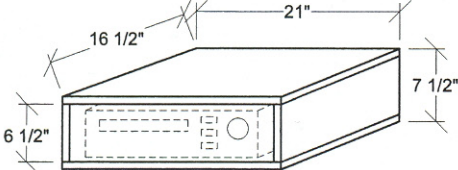
		CODE	PRICE
	<b>IRONING BOARD DOOR ONLY</b>	IRONCODE	100 plus door
	<b>CHINA DISPLAY RACK</b> •China Rack opening in 13" top to bottom •1-1/2" wide •Indicate larger options	FR  PRSQ (Square Dividers)	*150 PER FT.  *200 PER FT.
	<b>WALL SPICE RACKS</b> •Units are finished inside and out to match specified wood species and color •Mounts below wall cabinet	WSRS  WSRD	100  150
	<b>CUP SHELF</b> •Specified panels are made of solid wood •Shelf is grooved for plates.	CUPSH	150 PER FT.
	<b>VCR SHELF</b> Includes wood interior and integrated finish ends	VCR21  VCR27  VCR33	250  275  300

\*Price does not include  
cabinet or wood interior

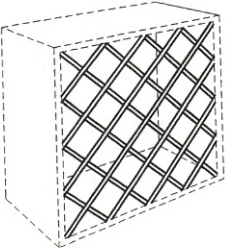
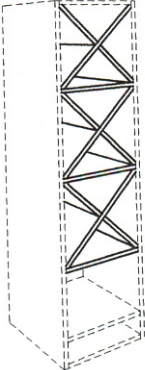
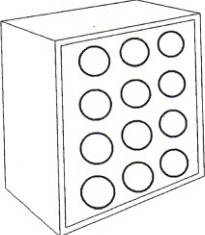
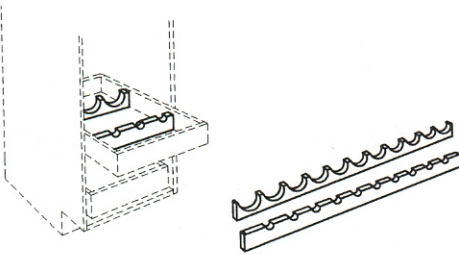
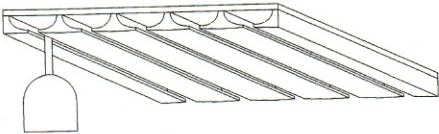
		CODE	PRICE
	<p>LATTICE WINE STORAGE</p> <ul style="list-style-type: none"> <li>•Lattice Only</li> </ul> <p>Add for cabinet Add for wood interior Add for face frame</p>	LWR	65 PER FT.
	<p>CRISSCROSS WINE STORAGE</p> <ul style="list-style-type: none"> <li>•Crisscross only</li> </ul> <p>Add for cabinet Add for wood interior Add for face frame</p>	CWR	120 PER SQ. FT.
	<p>ROUND WINE STORAGE</p> <ul style="list-style-type: none"> <li>•Round storage only</li> </ul> <p>Add for cabinet Add for wood interior Add for face frame</p>	RWR	65 PER SQ. FT.
	<p>WINE RACK CRADLE</p> <ul style="list-style-type: none"> <li>•6" Spacing</li> </ul>	WRC	35 PER FT.
	STEMWARE RACK	SWR	90 PER FT.

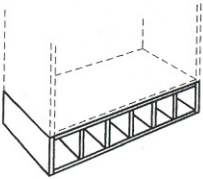
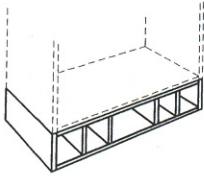
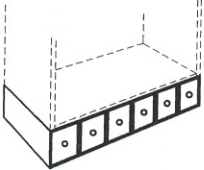
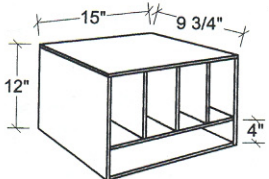
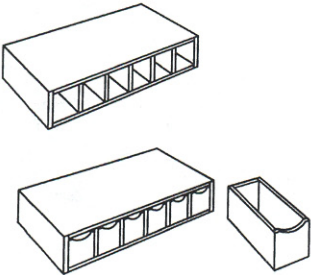
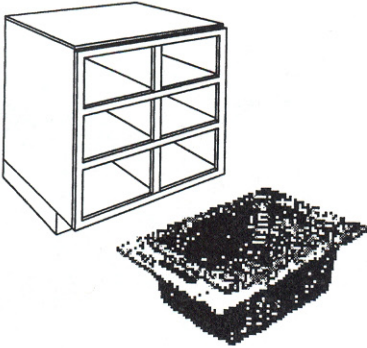

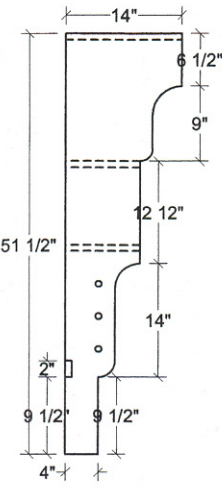
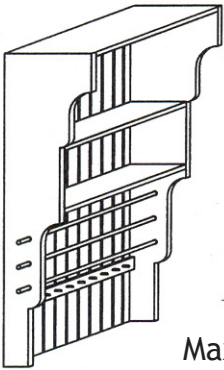
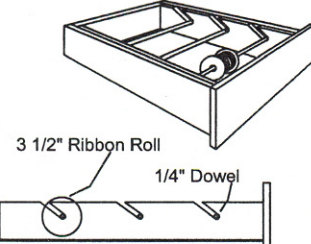
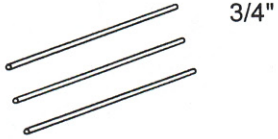
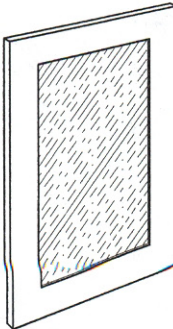

			CODE	PRICE
	LETTER SLOTS	Melamine	LSM	100 PER SQ. FT.
		Wood	LSW	200 PER SQ. FT.
	LETTER SLOTS	Melamine	LSPBM	100 PER SQ. FT.
		Wood	LSPBW	200 PER SQ. FT.
	WDR DRAWER		WDRD	150 PER SQ. FT.
	Add per drawer Add for fronts		DRAWER	150
	PHONE BOOK CADDY	Melamine	PBCM	200
		Wood	PBCW	250
	PIGEONHOLE DRAWERS •No Face Frames •No Guides	Pigeonhole baltic birch drawers	PH	100 PER CUBBY
		Pigeonhole dovetail drawers	PHDBB	125 EA.
			PHDDOVE	200 EA.
	BASKET CABINET •Price regular cabinet		BASKETM	100 PER OPENING
		Add for melamine interior	BASKET2	175 PER OPENING
		Add for wood interior	BKT	200 EA.
		Hafele Baskets 11-1/4" W x 21-1/4" L x 8 H 14-1/4" W x 21-1/4" L x 8 H		

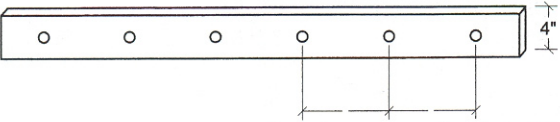
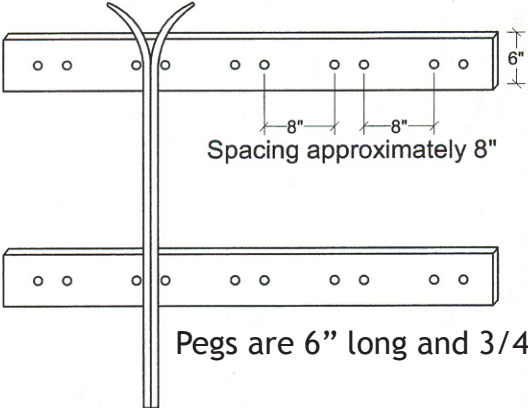

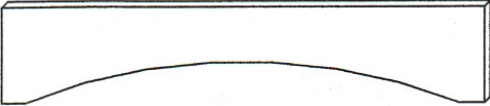
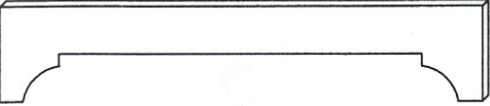
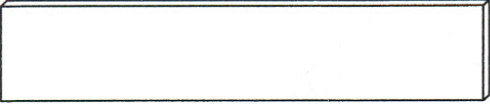
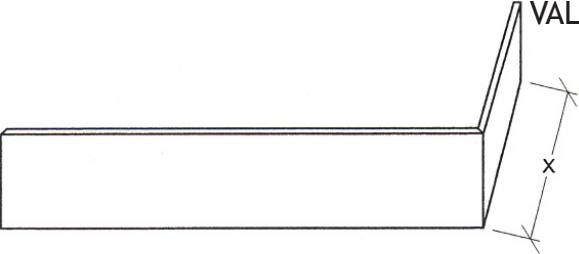
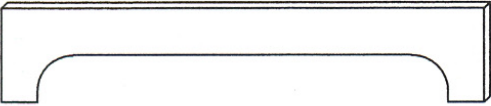
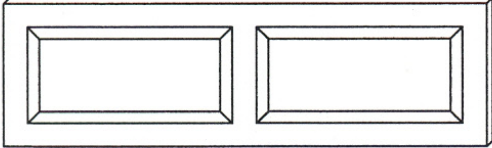
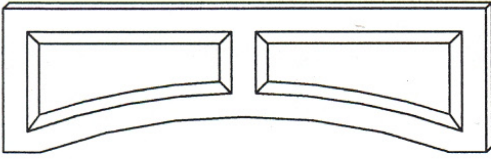
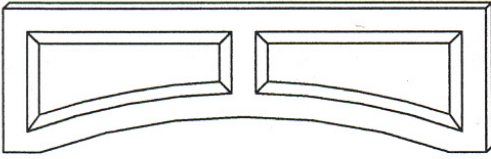
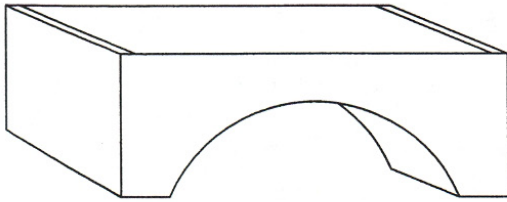
	CODE	PRICE
 <p><b>WRAPPING CENTER</b>  •Free Standing Only</p> <p>•No Fillers  Includes</p> <p>Cup Holders  Bead Board Back  Dowels  Shelves  Top Trim  1" Thick End Panel  30" Roll of Wrapping Paper  Maximum size 36" Wide x 52" High</p> 	WRAP	2100
 <p><b>RIBBON DRAWER</b>  •Includes 3 Drawers</p>	RD	130
 <p><b>WRAPPING CENTER DOWELS</b>  •For built in wrapping centers</p>	DOW	50 EACH
 <p><b>BLACK BOARD</b></p> <p><b>CORK BOARD</b></p> <p><b>MAGNETIC CHALK BOARD</b>  <b>MAGNETIC WHITE BOARD</b></p> <p>•Includes Frame</p>	BLACK CORK MAGNETCHALK MAGNETWHITE	65 PER SQ. FT. 65 PER SQ. FT. ASK GM FOR CUSTOM PRICING

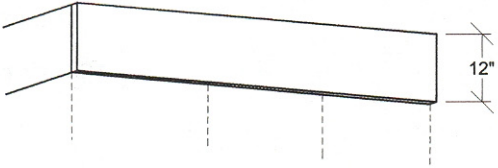
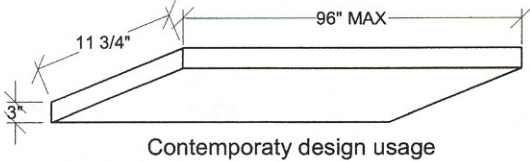
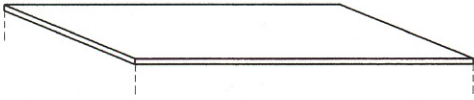
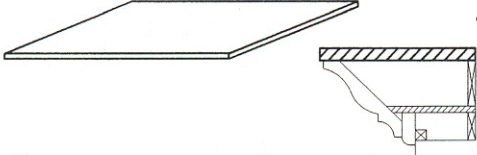
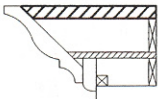

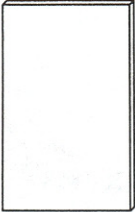
	CODE	PRICE
<p style="text-align: center;"><b>COAT RACK</b></p>  <p style="text-align: center;">Spacing approximately 8"</p> <p>Coat pegs are 2-5/8" long and 1" in diameter</p>	<p style="text-align: center;">COATRACK</p>	<p style="text-align: center;">10 PER FT.</p>
<p style="text-align: center;"><b>SKI RACK</b></p>  <p style="text-align: center;">Spacing approximately 8"</p> <p>Pegs are 6" long and 3/4" in diameter</p>	<p style="text-align: center;">SKIRACK</p>	<p style="text-align: center;">40 PER FT.</p>

			<b>CODE</b>	<b>PRICE</b>
	<b>VALANCE 1</b>		VAL001	100 PER FT.
	<b>VALANCE 2</b>		VAL002	125 PER FT.
	<b>VALANCE 4</b>		VAL004	50 PER FT.
	<b>VALANCE 4R</b>		VAL004R	75 PER FT.
	<b>VALANCE 6</b>		VAL006	125 PER FT.
	<b>VALANCE 7</b>	Up to 16" high	VAL007A	125 PER FT.
		17" to 24" high	VAL007B	135 PER FT.
			VAL007C	145 PER FT.
	<b>VALANCE 8</b>	Up to 16" high	VAL008A	170 PER FT.
		17" to 24" high	VAL008B	180 PER FT.
			VAL008C	190 PER FT.
	<b>VALANCE 8</b>	17" to 24" high	VAL008AT	190 PER FT.
			VAL008BT	200 PER FT.
			VAL008CT	210 PER FT.
	<b>VALANCE 1000</b>		VAL1000	300 PER FT.
	Add for Raised Panels			
	<b>CUSTOM VALANCE</b>		VAL	SEE GM FOR CUSTOM PRICING

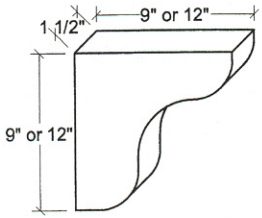
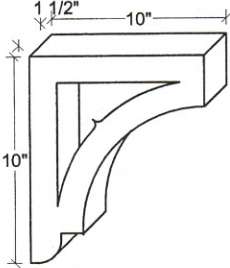
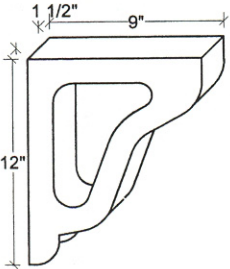
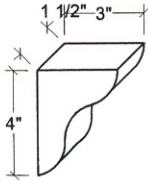
		<b>CODE</b>	<b>PRICE</b>
 <p><b>SOFFIT PANEL</b></p>		SOFFIT	24 PER SQ. FT.
 <p><b>PLATFORM</b></p> <p>Contemporary design usage</p>		PLATFORM	31 PER SQ. FT.
 <p><b>FLOOR</b></p>		FLOOR	50 PER FT.
 <p><b>OVERHEAD CABINET DECKING</b></p> <ul style="list-style-type: none"> <li>Includes a wood detailed edge 3/4"</li> </ul>		OVERDECK3	30 PER SQ. FT.
		OVERDECK1	20 PER SQ. FT.
 <ul style="list-style-type: none"> <li>Melamine behind corner 3/4"</li> </ul>		OVERDECKM	20 PER SQ. FT.
  <p><b>CUSTOM PANELS</b></p> <ul style="list-style-type: none"> <li>3/4" Skins</li> </ul>	MDF	PANELMDF	14 PER SQ. FT.
	Wood grain	PANELWD	24 PER SQ. FT.
	Bead Board	PANELBB	45 PER SQ. FT.
  <p><b>CUSTOM PANELS</b></p> <ul style="list-style-type: none"> <li>1/4" Skins</li> </ul>	MDF	SKINMDF	10 PER SQ. FT.
	Wood grain	SKINWD	20 PER SQ. FT.
	Bead Board	SKINBB	45 PER

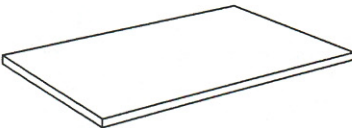
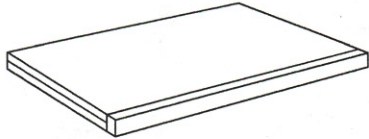
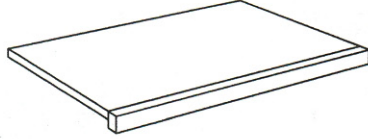
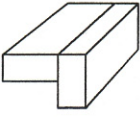
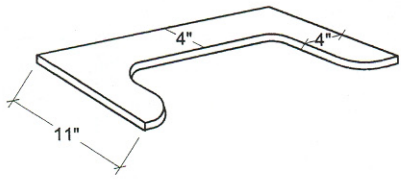
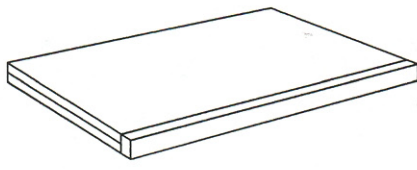
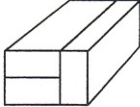
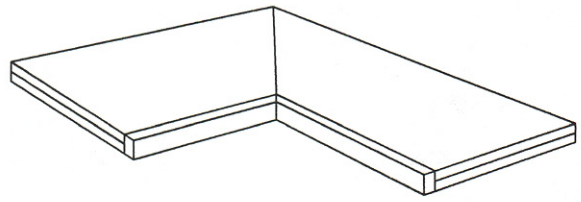
		CODE	PRICE
	<b>CORBEL A</b> 9 x 9 12 x 12	CORBELA	150
	If ordered with job		100
	<b>CORBEL B</b> 10 x 12	CORBELB	300
	If ordered with job		250
	<b>CORBEL C</b> 9 x 12	CORBELC	300
	If ordered with job		250
	<b>CORBEL D</b> 9 x 12	CORBELD	75

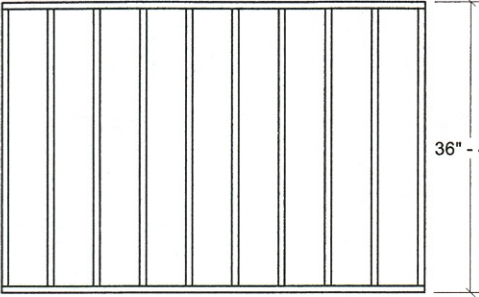
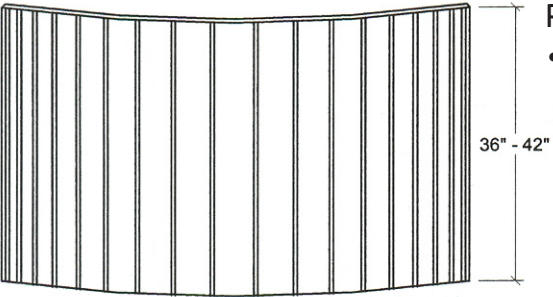
			<b>CODE</b>	<b>PRICE</b>
	<p><b>WOOD SHELVES</b> •3/4" Thick</p>	Veneer edge	WSV	30 PER SQ. FT.
		Solid Wood edge	WSW	40 PER SQ. FT.
	<p><b>WOOD SHELVES</b> •Double Thick •1-1/2" Thick</p>		WSD	90 PER SQ. FT.
 	<p><b>WOOD SHELVES WITH TRIM MOLD</b> 1-1/2" Nosing</p>		BKS	40 PER SQ. FT.
	<p><b>PANTRY SHELF</b></p>		PS	40 PER SQ. FT.
 	<p><b>STRAIGHT WOOD DECK</b> •Includes trim on 3 sides</p>		WD	80 PER SQ. FT.
	<p><b>ANGLE WOOD DECK</b> •Price Wood Deck  •Add per angle or miter</p>		WDA	100 PER ANGLE

	CODE	PRICE
 <p><b>PONY WALL</b> • 2 x 4 Construction</p> <p>36" - 42"</p> <p><i>IF ORDERED WITH COMPLETE JOB</i></p>	PONY	50 PER SQ. FT.  35 PER SQ. FT.
 <p><b>PONY WALL RADIUS</b> • 1 x 4 Construction</p> <p>36" - 42"</p> <p><i>IF ORDERED WITH COMPLETE JOB</i></p>	PONYRAD	75 PER SQ. FT.  50 PER SQ. FT.
 <p><b>QUARTER RADIUS</b></p>	1/4RAD	500
 <p><b>HALF RADIUS</b></p>	1/2RAD	600

**PARTS**

*Carriage House, Fine Kitchen Cabinetry*

**16.12**

		CODE	PRICE
BOOTH SEATS Add for Back Panel Add for End Panel Add for mitered corners		BOOTH	350 PER FT. 26 PER SQ. FT. 250 EACH 300 PER MITER
	BENCH LIFT-UP TOP LIFTTOP	SPECIFY SIZE	160 PER SQ. FT.



**PARTS**

*Carriage House, Fine Kitchen Cabinetry*

**16.13**

**CODE**

**PRICE**



The image contains two technical line drawings of kitchen hardware. On the left is a detailed view of a cabinet door pull, showing its curved shape and the mounting mechanism. On the right is a drawing of a cabinet knob, showing its decorative, multi-faceted design and the stem for attachment.

# ACCESSORIES





*Carriage House*  
*Fine Kitchen Cabinetry*

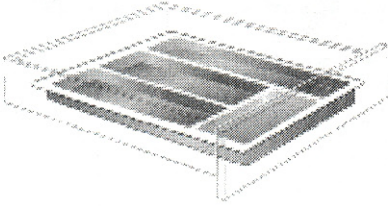
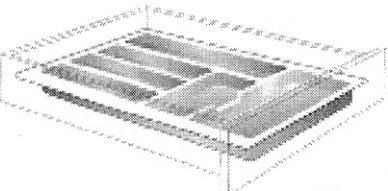
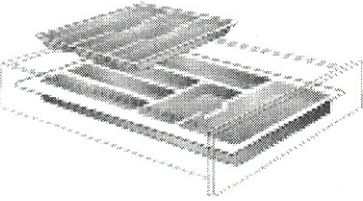
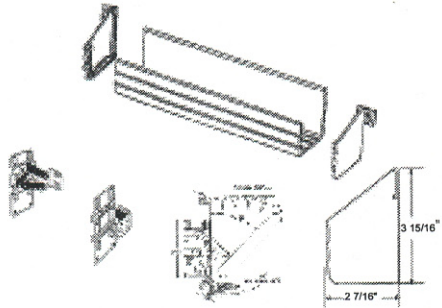
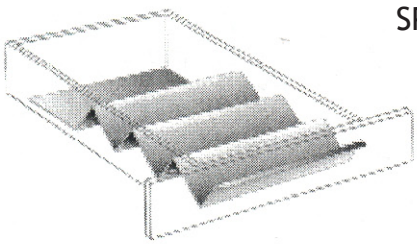
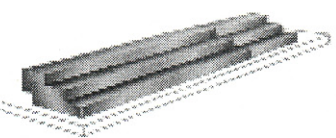

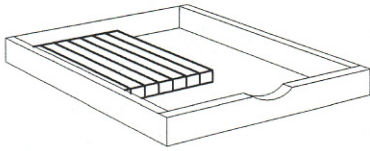
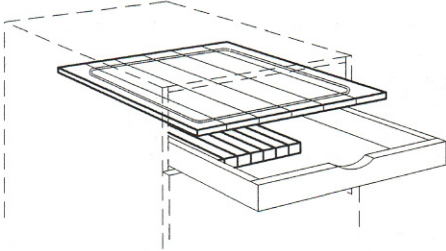
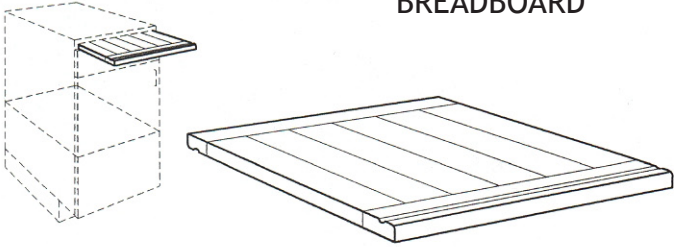
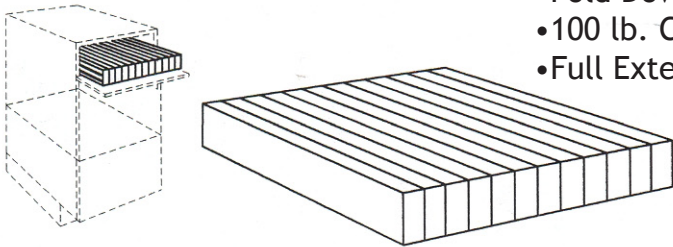
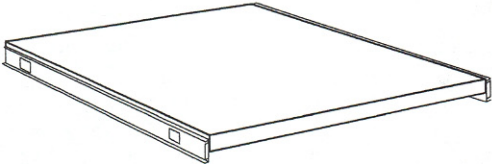

		<b>CODE</b>	<b>PRICE</b>										
	<p><b>UTILITY TRAY DRAWER INSERTS</b>                      • 2-3/8" DEEP</p> <p style="text-align: center;">WIDTH</p> <table border="1" style="margin-left: auto; margin-right: auto;"> <thead> <tr> <th>Max</th> <th>Min</th> </tr> </thead> <tbody> <tr> <td>11-1/2"</td> <td>8-5/8"</td> </tr> <tr> <td>14-1/4"</td> <td>11-5/8"</td> </tr> <tr> <td>17-1/2"</td> <td>14-3/4"</td> </tr> <tr> <td>21-7/8"</td> <td>18-3/8"</td> </tr> </tbody> </table>	Max	Min	11-1/2"	8-5/8"	14-1/4"	11-5/8"	17-1/2"	14-3/4"	21-7/8"	18-3/8"	UT	130
Max	Min												
11-1/2"	8-5/8"												
14-1/4"	11-5/8"												
17-1/2"	14-3/4"												
21-7/8"	18-3/8"												
	<p><b>TABLEWARE TRAY INSERTS</b>                      • 2-3/8" DEEP</p> <p style="text-align: center;">WIDTH</p> <table border="1" style="margin-left: auto; margin-right: auto;"> <thead> <tr> <th>Max</th> <th>Min</th> </tr> </thead> <tbody> <tr> <td>11-1/2"</td> <td>8-5/8"</td> </tr> <tr> <td>14-1/4"</td> <td>11-5/8"</td> </tr> <tr> <td>17-1/2"</td> <td>14-3/4"</td> </tr> <tr> <td>21-7/8"</td> <td>18-3/8"</td> </tr> </tbody> </table>	Max	Min	11-1/2"	8-5/8"	14-1/4"	11-5/8"	17-1/2"	14-3/4"	21-7/8"	18-3/8"	CT	130
Max	Min												
11-1/2"	8-5/8"												
14-1/4"	11-5/8"												
17-1/2"	14-3/4"												
21-7/8"	18-3/8"												
	<p><b>DOUBLE-TIERED CUTLERY TRAY</b></p> <p style="text-align: center;">WIDTH</p> <table border="1" style="margin-left: auto; margin-right: auto;"> <thead> <tr> <th>Max</th> <th>Min</th> </tr> </thead> <tbody> <tr> <td>14-3/4"</td> <td>12-1/4"</td> </tr> <tr> <td>20-3/4"</td> <td>18-1/4"</td> </tr> </tbody> </table>	Max	Min	14-3/4"	12-1/4"	20-3/4"	18-1/4"	CTD	230				
Max	Min												
14-3/4"	12-1/4"												
20-3/4"	18-1/4"												
	<p><b>TIP-OUT UTILITY TRAYS</b></p>	TO	130										
	<p><b>SPICE DRAWER INSERT</b></p>	SDI	180										
	<p><b>STAIR SHELF                      ADJUSTABLE SPICE RACK</b></p> <ul style="list-style-type: none"> <li>• Adjusts from 14" to 27" Wide</li> <li>• 8" Deep</li> <li>• 4-1/8" High</li> </ul>	SSS	75										

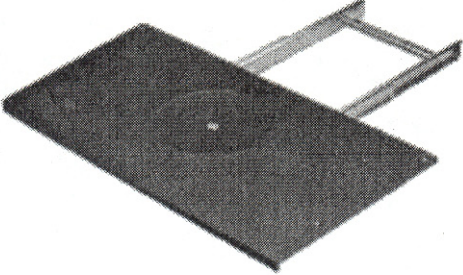
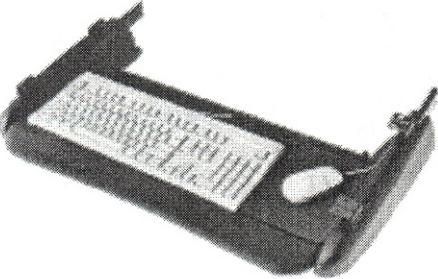
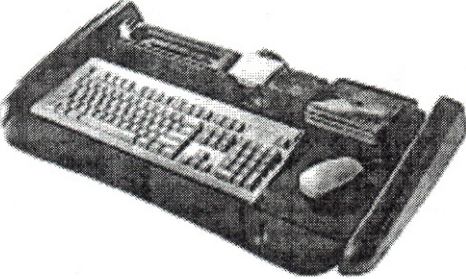
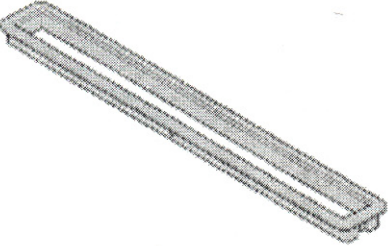
		CODE	PRICE
	<p><b>KNIFE BLOCK</b></p> <ul style="list-style-type: none"> <li>•1-1/2" Butcher Block Insert</li> <li>•Indicate approximate size</li> </ul>	KB	160
	<p><b>KNIFE DRAWER/BREAD BOARD</b></p> <ul style="list-style-type: none"> <li>•1-1/2" Knife Block</li> <li>•3/4" Bread Board</li> </ul>	KD/BB	500
	<p><b>BREADBOARD</b></p> <p>Alder Wood</p>	BB	140
	<p><b>BREADBOARD BUTCHER BLOCK</b></p> <ul style="list-style-type: none"> <li>•Fold Down Breadboard</li> <li>•100 lb. Capacity</li> <li>•Full Extension Glides</li> </ul>	FDBB	300
	<p><b>PULL-OUT SHELF</b></p> <ul style="list-style-type: none"> <li>•100 lb. Capacity</li> <li>•Full Extension Glides</li> </ul> <p>Melamine</p> <p>Wood</p>	<p>POSMEL</p> <p>POSWD</p>	<p>100</p> <p>125</p>



			<b>CODE</b>	<b>PRICE</b>						
	<p><b>PULL-OUT TABLE</b> •Special Pricing</p>	<p>60"</p>	<p>POTABLE</p>	<p>2000</p>						
	<p><b>EXTENSION TABLE SLIDES</b> •175 lb. Capacity</p>	<p>For additional work surface in kitchen or office. A lever system in the front allows the drawer front to swing down and out of the way when pulled out.</p>	<p>ETS</p>	<p>400</p>						
	<p><b>FILES</b> •16" Min for Letter •20" Min for Legal •100 lb. Capacity</p>	<p>All Files Must be Indicated Letter or Legal</p>	<p>RFA</p>	<p>320</p>						
	<p><b>LATERAL FILES</b> •16" Deep Min. for Letter •18" Deep Min. for Legal</p>	<p>•Includes File Racks •Includes Full Extension Guides</p>	<p>LFA24</p>	<p>320</p>						
<p>LFA30</p>	<p>350</p>									
	<p><b>FILE HOLDER PULL-OUT</b></p>	<table border="1"> <thead> <tr> <th>Width</th> <th>Depth</th> </tr> </thead> <tbody> <tr> <td>15"</td> <td>18"</td> </tr> <tr> <td>15"</td> <td>22"</td> </tr> </tbody> </table>	Width	Depth	15"	18"	15"	22"	<p>FHPO</p>	<p>240</p>
Width	Depth									
15"	18"									
15"	22"									

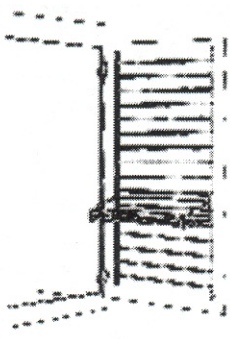

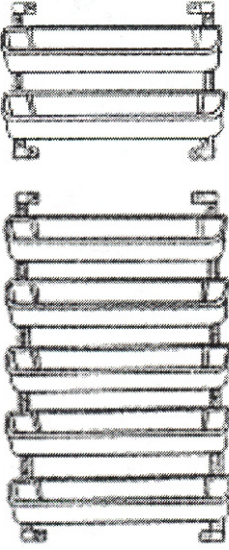
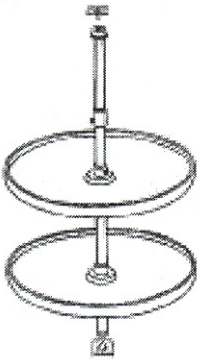
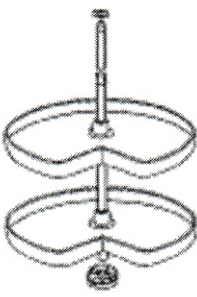
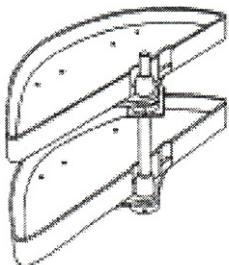

		<b>CODE</b>	<b>PRICE</b>
	<p><b>TV SWIVEL / PULL-OUT</b></p> <ul style="list-style-type: none"> <li>•150 lb. Capacity</li> <li>•Full Extension Guides</li> <li>•Brown</li> <li>•Minimum Opening 30"</li> <li>•TVS is bolted to shelf</li> </ul>	TVS	400
	<p><b>KEYBOARD TRAY</b></p> <ul style="list-style-type: none"> <li>•Fully Concealed, 3/4" extension slides</li> <li>•Foam Palm Rest</li> </ul>	KBPO	440
	<p><b>KEYBOARD TRAY DELUXE</b></p> <ul style="list-style-type: none"> <li>•Fully Concealed, Full extension slides</li> <li>•Gel Palm Rest</li> <li>•Rear Storage Compartments</li> <li>•Adjustable Keyboard Platform</li> </ul>	KBPOTD	440
	<p><b>PAPER MANAGER</b></p> <ul style="list-style-type: none"> <li>•Almond</li> <li>•Black</li> <li>•Brown</li> <li>•Light Grey</li> </ul>	PMG	50
	<p><b>ROUND PLASTIC GROMMETS</b></p> <ul style="list-style-type: none"> <li>•Black</li> <li>•Dark Brown</li> <li>•Light Grey</li> <li>•White</li> <li>•Brass and Chrome (not all sizes)</li> </ul> <p>3/4", 1-1/2", 1-3/4", 2", 2-1/2", 3", 3-1/2", 4"</p>	RPG	50

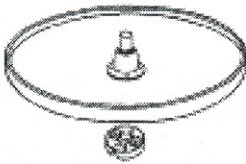

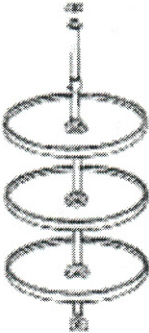
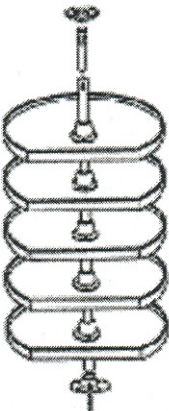

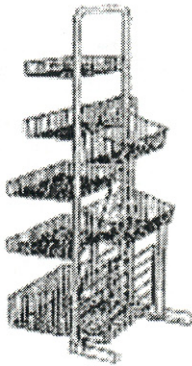
		<b>CODE</b>	<b>PRICE</b>
	<p><b>DOOR LADDER</b></p> <p>25" Tall</p> <p>47" Tall</p> <p>59" Tall</p> <p>10-3/4" W x 3-1/2" H x 4" D</p>	<p>DL25</p> <p>DL47</p> <p>DL59</p>	<p>200</p> <p>250</p> <p>300</p>
	<p><b>SWING OUT PANTRY</b></p> <p>21-5/16" Tall</p> <p>42-5/8" Tall</p> <p>56" Tall</p> <p>10-3/4" W x 3-1/2" H x 4" D</p>	<p>SOP21</p> <p>SOP42</p> <p>SOP56</p>	<p>230</p> <p>280</p> <p>280</p>
	<p><b>BASIC™ TWO-TIER DOOR/WALL RACK</b></p> <ul style="list-style-type: none"> <li>•Basic Wall Rack</li> <li>•10-1/2" X 18-1/4" X 5"</li> </ul>	<p>BWR</p>	<p>75</p>
	<p><b>WIRE SPICE RACKS</b></p> <p>RV565</p> <ul style="list-style-type: none"> <li>•7-7/8" Wide</li> <li>•10-5/8" Wide</li> <li>•13-5/8" Wide</li> <li>•White</li> <li>•Three shelves 2-3/8" deep</li> <li>•Bottom shelf for canned goods 4-1/8" deep</li> <li>•Overall height: 21-3/8".</li> </ul>	<p>SRA</p>	<p>200</p>
	<p><b>WOOD SPICE RACK</b></p> <p>RV4SR</p> <ul style="list-style-type: none"> <li>•1/2" Baltic Birch</li> <li>•3-1/2" Deep</li> <li>•14" High</li> <li>•3/8" Dowels</li> </ul>	<p>WSR</p>	<p>250</p>

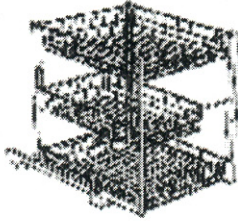
		<b>CODE</b>	<b>PRICE</b>
	<b>DOOR STORAGE TRAYS</b> Upper Door Storage Tray Sets		
	7-7/8"	DSTU7	60
	13-3/4"	DSTU13	60
	19-3/4"	DSTU19	65
	Lower Door Storage Tray Sets		
	7-7/8"	DSTL7	125
	13-3/4"	DSTL13	125
19-3/4"	DSTL19	135	
Minimum opening size of 8-7/8" required			
	<b>LAZY SUSAN FULL ROUND</b>		
	Diameter		
	18"	LSR18	400
	20"	LSR20	460
	24"	LSR24	540
	28"	LSR28	580
32"	LSR32	610	
			PER SET
	<b>KIDNEY LAZY SUSAN</b>	LSK	430
	Adjustable for cabinet heights of 26" to 31"		PER SET
	<b>LAZY SUSAN HALF MOON</b> •Includes 2 pivot and slide trays	LSHM	475
			PER SET

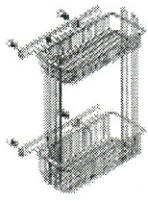
		<b>CODE</b>	<b>PRICE</b>	
 <p><b>LAZY SUSAN FULL ROUND SINGLE TRAY</b></p> <p>Comes with 1 shelf, and 5" Mounting shaft with cap.</p>	Diameter	LSRST	170 175 220 270 PER SET	
	16"			
	18"			
	28"			
	32"			
 <p><b>SUPER SUSAN</b></p> <p>Melamine Shelf with Chrome Ring</p>		SS	210	
 <p><b>LAZY SUSAN FULL ROUND</b></p> <ul style="list-style-type: none"> <li>•Three Tray Sets</li> </ul> <p>Adjustable for cabinet heights of 36" to 42"</p>	Diameter	LSR3	450 PER SET	
	18"			
 <p><b>REVOLVING "D" SHELF PANTRY SYSTEM</b></p> <ul style="list-style-type: none"> <li>•"D" Shaped shelf sets for use in 24" deep cabinet</li> <li>•22" diameter shelves revolve independently and self-locate the last 30" to either side.</li> <li>•32 lbs. nominal load per shelf.</li> </ul> <p>Upper Set 2 "D" Shaped shelves adjustable from 26" to 32" High</p> <p>Lower Set 5 "D" Shaped shelves adjustable from 56" to 62" High</p>		UPPERSET	225	
		LOWERSET	650	

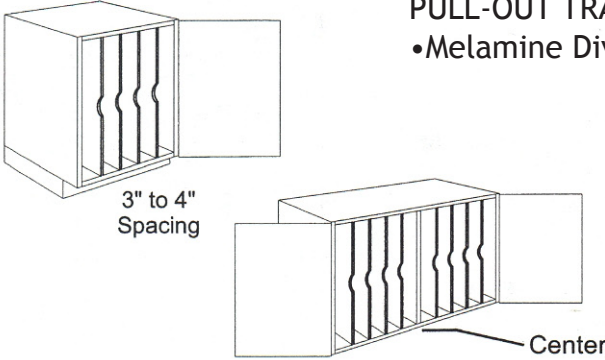
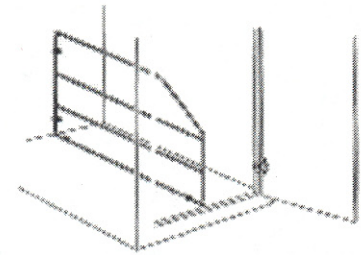
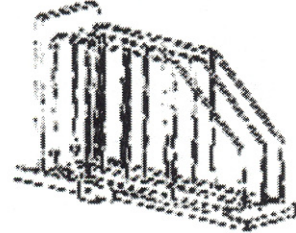
		<b>CODE</b>	<b>PRICE</b>																		
	<p><b>PULL-OUT PANTRY SYSTEM</b></p> <hr/> <table border="0"> <tr> <td><b>Width</b></td> <td><b>Basket Description</b></td> </tr> <tr> <td>15"</td> <td>6 Standard and 4 bin baskets</td> </tr> <tr> <td>18"</td> <td>6 Standard and 4 bin baskets</td> </tr> <tr> <td>21"</td> <td>6 Standard, 2 bin baskets, and 4 deep bin baskets</td> </tr> </table> <ul style="list-style-type: none"> <li>•Minimum cabinet depth of 22-1/2"</li> <li>•Minimum of 1/4" clearance on sides and top</li> <li>•175 lb. maximum Capacity</li> </ul>	<b>Width</b>	<b>Basket Description</b>	15"	6 Standard and 4 bin baskets	18"	6 Standard and 4 bin baskets	21"	6 Standard, 2 bin baskets, and 4 deep bin baskets	POP	2000										
	<b>Width</b>	<b>Basket Description</b>																			
15"	6 Standard and 4 bin baskets																				
18"	6 Standard and 4 bin baskets																				
21"	6 Standard, 2 bin baskets, and 4 deep bin baskets																				
	<p><b>BASE CABINET PANTRY PULL-OUT</b></p> <hr/> <table border="0"> <tr> <td><b>Width</b></td> <td><b>Basket Description</b></td> </tr> <tr> <td>12"</td> <td>2 - 3-3/8" standard, 2 - 6-3/8" standard</td> </tr> <tr> <td>15"</td> <td>2 - 6-3/8" standard, 2 - 6-3/8" standard</td> </tr> <tr> <td>21"</td> <td>2 - 7-3/8" standard, 2 - 7-3/8" standard</td> </tr> </table> <ul style="list-style-type: none"> <li>•21-7/8" Deep x 20-1/8" High</li> </ul>	<b>Width</b>	<b>Basket Description</b>	12"	2 - 3-3/8" standard, 2 - 6-3/8" standard	15"	2 - 6-3/8" standard, 2 - 6-3/8" standard	21"	2 - 7-3/8" standard, 2 - 7-3/8" standard	BPO	200										
	<b>Width</b>	<b>Basket Description</b>																			
12"	2 - 3-3/8" standard, 2 - 6-3/8" standard																				
15"	2 - 6-3/8" standard, 2 - 6-3/8" standard																				
21"	2 - 7-3/8" standard, 2 - 7-3/8" standard																				
	<p><b>3 BASKET ROLL-OUT</b></p> <hr/> <table border="0"> <tr> <td><b>Width</b></td> <td><b>Min. Opening</b></td> </tr> <tr> <td>12-1/4"</td> <td>12-3/4"</td> </tr> <tr> <td>15"</td> <td>15-3/4"</td> </tr> <tr> <td>17-1/8"</td> <td>18"</td> </tr> <tr> <td>20-1/16"</td> <td>20-1/2"</td> </tr> </table>	<b>Width</b>	<b>Min. Opening</b>	12-1/4"	12-3/4"	15"	15-3/4"	17-1/8"	18"	20-1/16"	20-1/2"	3BPO	390								
	<b>Width</b>	<b>Min. Opening</b>																			
12-1/4"	12-3/4"																				
15"	15-3/4"																				
17-1/8"	18"																				
20-1/16"	20-1/2"																				
	<table border="0"> <tr> <td>22"</td> <td>22-1/2"</td> </tr> <tr> <td>25-1/16"</td> <td>25-1/2"</td> </tr> </table>	22"	22-1/2"	25-1/16"	25-1/2"	3BPO	460														
22"	22-1/2"																				
25-1/16"	25-1/2"																				
	<p><b>WIRE ROLL-OUT SHELVES</b></p> <hr/> <table border="0"> <tr> <td><b>Width</b></td> <td><b>Depth</b></td> <td><b>Min. Opening</b></td> </tr> <tr> <td>9-1/4"</td> <td>18"</td> <td>9-1/2"</td> </tr> <tr> <td>12-1/4"</td> <td>18"</td> <td>12-3/4"</td> </tr> <tr> <td>15"</td> <td>22"</td> <td>15-3/4"</td> </tr> <tr> <td>17-1/8"</td> <td>22"</td> <td>18"</td> </tr> <tr> <td>20-1/16"</td> <td>22"</td> <td>20-1/2"</td> </tr> </table>	<b>Width</b>	<b>Depth</b>	<b>Min. Opening</b>	9-1/4"	18"	9-1/2"	12-1/4"	18"	12-3/4"	15"	22"	15-3/4"	17-1/8"	22"	18"	20-1/16"	22"	20-1/2"	WROS	260
	<b>Width</b>	<b>Depth</b>	<b>Min. Opening</b>																		
9-1/4"	18"	9-1/2"																			
12-1/4"	18"	12-3/4"																			
15"	22"	15-3/4"																			
17-1/8"	22"	18"																			
20-1/16"	22"	20-1/2"																			
	<table border="0"> <tr> <td>27-1/16"</td> <td>22"</td> <td>27-1/2"</td> </tr> <tr> <td>32-7/8"</td> <td>22"</td> <td>33-1/4"</td> </tr> </table>	27-1/16"	22"	27-1/2"	32-7/8"	22"	33-1/4"	WROS	390												
27-1/16"	22"	27-1/2"																			
32-7/8"	22"	33-1/4"																			
	<p>Narrow Roll-Out Base Unit</p> <ul style="list-style-type: none"> <li>•Non-handed and reversible</li> <li>•Can be door mounted</li> <li>•12-1/2" extension on slides</li> </ul> <p>6-3/8" W x 19 3/8" D x 19-1/2" H</p>	ROBU	330																		

		<b>CODE</b>	<b>PRICE</b>
 <p><b>PULL-OUT TRAY DIVIDER</b> •Melamine Dividers</p>	TDPO	75 EACH	
 <p><b>TRAY DIVIDERS</b> •Wire</p>	TD	50 EACH	
 <p><b>ROLL-OUT TRAY DIVIDERS</b> •Includes 3 Tray Dividers</p>	TDRO	300	
 <p><b>TOWEL BAR</b></p> <p>6-1/4" H x 12-3/8" W x 4-1/2" D</p>	TB	50	
 <p><b>TOWEL BAR</b> •Three Prong Rack •12" Extension</p> <p>5" W x 17-3/4" L x 1-1/4" D</p>	TBPO	150	

TWO-BIN  
•2 - 27 c

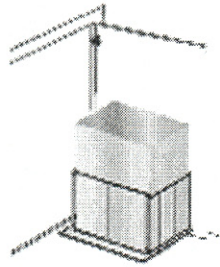

**"BAG-IT ALL" TRASH HOLDER**  
Door Mounted

Minimum Opening Required  
15" Wide  
17-1/2" High  
7-1/2" Deep

**CODE**

**PRICE**

BIA

75



Floor Mount

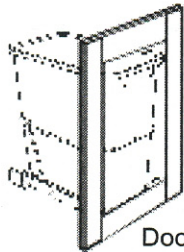

Door Mount

**SINGLE-BIN SLIDE-OUT**  
Waste Containers  
•20 quart Capacity Bin

Minimum Opening Required

Floor Mount	Door Mount
15-3/4" W	15" W
16" H	16" H
16" D	22" D

RG20

250

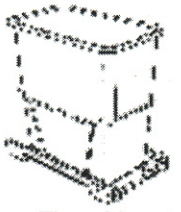

Floor Mount

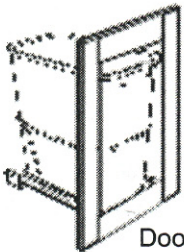

Door Mount

**SLIDE-OUT WASTE BASKETS**  
•30 quart Capacity Bin

Minimum Opening Required

Floor Mount	Door Mount
11-1/4" W	10-1/2" W
19-1/2" H	19-1/2" H
22" D	22" D

RG30

250

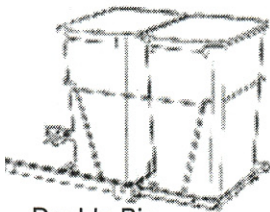

Double Bin  
Floor Mount

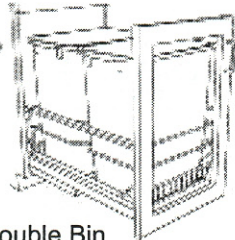

Double Bin  
Door Mount

**DOUBLE BIN SLIDE-OUT**  
WASTE CONTAINERS  
•20 quart Capacity Bin

Minimum Opening Required

Floor Mount	Door Mount
15-3/4" W	15" W
16" H	16" H
16" D	22" D

RG40

500

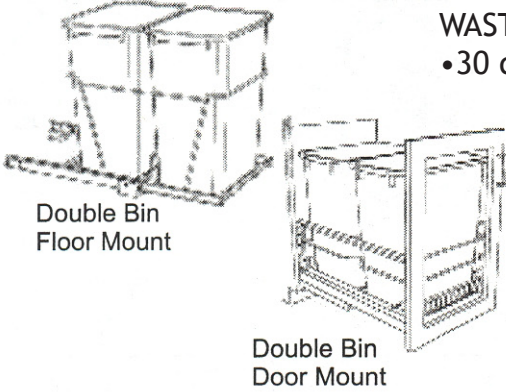
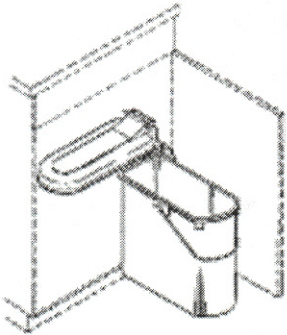
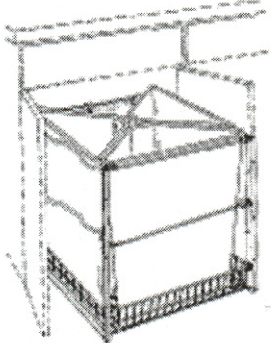
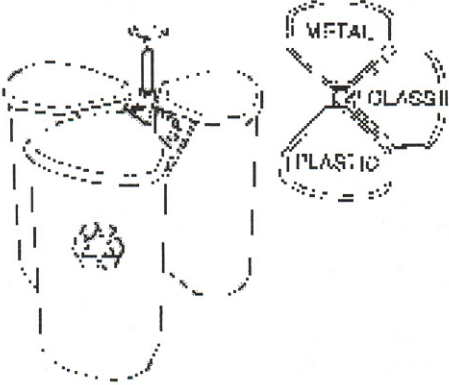
		<b>CODE</b>	<b>PRICE</b>										
 <p>Double Bin Floor Mount</p> <p>Double Bin Door Mount</p>	<p><b>DOUBLE BIN SLIDE-OUT WASTE CONTAINERS</b>                      •30 quart Capacity Bin</p>	<p>RG60</p>	<p>500</p>										
<table border="1"> <thead> <tr> <th colspan="2">Minimum Opening Required</th> </tr> <tr> <th>Floor Mount</th> <th>Door Mount</th> </tr> </thead> <tbody> <tr> <td>17-1/4" W</td> <td>16-1/2" W</td> </tr> <tr> <td>20" H</td> <td>20" H</td> </tr> <tr> <td>16" D</td> <td>22" D</td> </tr> </tbody> </table>		Minimum Opening Required		Floor Mount	Door Mount	17-1/4" W	16-1/2" W	20" H	20" H	16" D	22" D		
Minimum Opening Required													
Floor Mount	Door Mount												
17-1/4" W	16-1/2" W												
20" H	20" H												
16" D	22" D												
	<p><b>PIVOT-OUT WASTE CONTAINER</b>                      •21 quart Capacity Bin</p> <p>Minimum Opening Required                      14-1/2" Wide                      14" High                      7-1/2" Deep</p>	<p>POWC</p>	<p>380</p>										
	<p><b>WASTE MANAGEMENT SYSTEM</b>                      •3 - 25 quart Bins &amp; Bag                      •Full Extension Units                      •White or Colored Bins</p> <p>Minimum Opening Required                      20-3/8" Wide                      20" High                      22" Deep</p>	<p>WMS</p>	<p>650</p>										
	<p><b>ROTARY RECYCLING CENTER</b>                      •3 - 32 quart Bins                      •28" Diameter</p> <p>Minimum Opening Required</p> <p>14-3/8" Door Opening                      28-1/2" to 30-1/2" High                      19" Deep Corner Cabinet</p>	<p>RRC</p>	<p>675</p>										

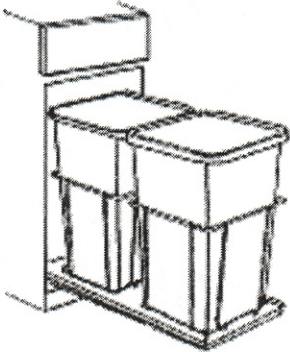
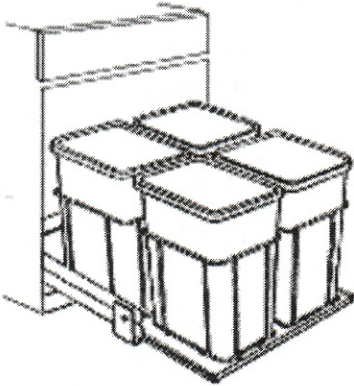
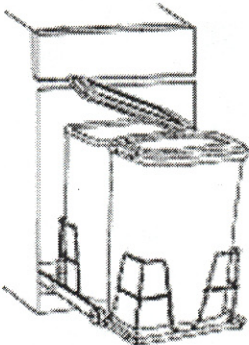
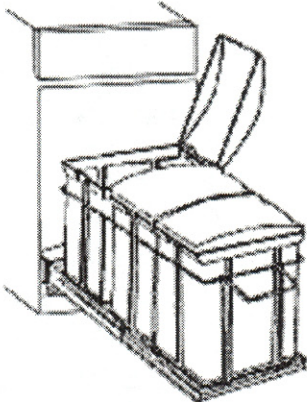
		<b>CODE</b>	<b>PRICE</b>
 <p><b>TWO-BIN RECYCLING CENTER</b> •2 - 27 quart Bins</p> <p>Minimum Opening Required 12-3/4" Wide 19-1/2" High 23" Deep</p>		2RC	400
 <p><b>FOUR-BIN RECYCLING CENTER</b> •4 - 27 quart Bins</p> <p>Minimum Opening Required 24-1/2" Wide 19-1/2" High 23" Deep</p>		4RC	580
 <p><b>SEALED RECYCLING CENTER</b> •2 - 20 quart Bins</p> <p>Minimum Opening Required 15-3/4" Wide 19-1/2" High 22" Deep</p>		2SRC	400
 <p><b>SEALED RECYCLING CENTER</b> •3 - 20 quart Bins</p> <p>Minimum Opening Required 15-3/4" Wide 19-1/2" High 22" Deep</p>		3SRC	500





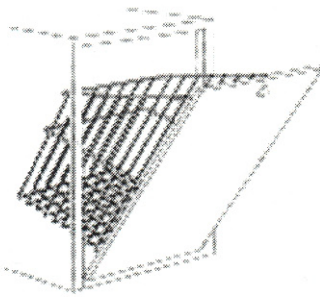
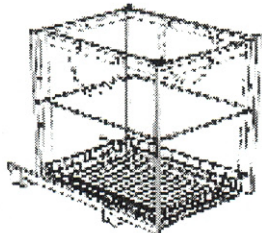
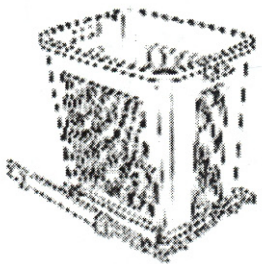

		<b>CODE</b>	<b>PRICE</b>
	<p><b>BALTIC BIRCH PULL-OUT</b>                      • Fits B1-9 or VB-9</p>	<p>BALTICPO</p>	<p>600</p>
	<p><b>BALTIC BIRCH SPICE RACK PULL-OUT</b>                      • Fits B9</p>	<p>BSLTIVDPO</p>	<p>600</p>
	<p><b>BALTIC BIRCH TOWEL PULL-OUT</b>                      • Fits B9                      • Paper Towel Holder                      • 1 Stainless Steel Bin</p>	<p>BALTICPO</p>	<p>600</p>
	<p><b>BALTIC BIRCH BIN PULL-OUT</b>                      • Fits B9                      • 2 Stainless Steel Bins                      • 3 Stainless Steel Canisters</p>	<p>BALTICBPO</p>	<p>700</p>

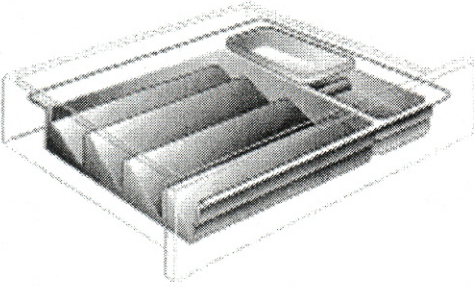
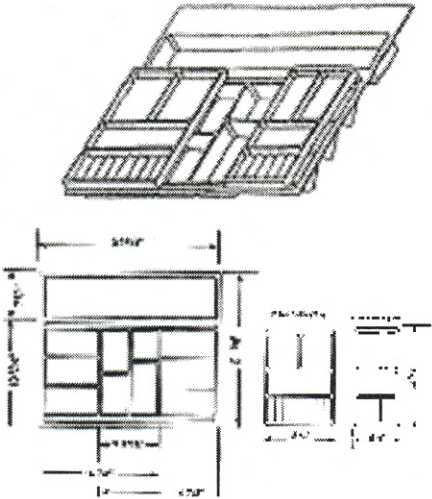
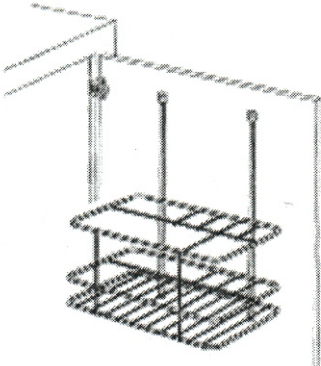
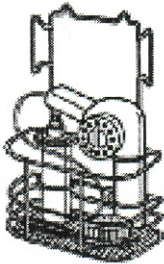
		<b>CODE</b>	<b>PRICE</b>														
	<p><b>TILT-OUT HAMPER</b> Minimum Opening Required</p> <table border="1"> <thead> <tr> <th>Width</th> <th>Height</th> <th>Depth</th> </tr> </thead> <tbody> <tr> <td>10-1/2"</td> <td>17-3/4"</td> <td>18-3/4"</td> </tr> <tr> <td>13-1/2"</td> <td>17-3/4"</td> <td>18-3/4"</td> </tr> <tr> <td>16-1/2"</td> <td>17-3/4"</td> <td>18-3/4"</td> </tr> </tbody> </table>	Width	Height	Depth	10-1/2"	17-3/4"	18-3/4"	13-1/2"	17-3/4"	18-3/4"	16-1/2"	17-3/4"	18-3/4"	TOH	120		
	Width	Height	Depth														
10-1/2"	17-3/4"	18-3/4"															
13-1/2"	17-3/4"	18-3/4"															
16-1/2"	17-3/4"	18-3/4"															
<p><b>HAMPER ROLL-OUT</b> Minimum Opening Required</p> <table border="1"> <thead> <tr> <th>Width</th> <th>Height</th> <th>Depth</th> </tr> </thead> <tbody> <tr> <td>11-3/4"</td> <td>14-1/4"</td> <td>18-3/4"</td> </tr> <tr> <td>14-3/4"</td> <td>14-1/4"</td> <td>18-3/4"</td> </tr> <tr> <td>11-3/4"</td> <td>18-1/2"</td> <td>18-3/4"</td> </tr> <tr> <td>14-3/4"</td> <td>18-1/2"</td> <td>18-3/4"</td> </tr> </tbody> </table>	Width	Height	Depth	11-3/4"	14-1/4"	18-3/4"	14-3/4"	14-1/4"	18-3/4"	11-3/4"	18-1/2"	18-3/4"	14-3/4"	18-1/2"	18-3/4"	ROH	220
Width	Height	Depth															
11-3/4"	14-1/4"	18-3/4"															
14-3/4"	14-1/4"	18-3/4"															
11-3/4"	18-1/2"	18-3/4"															
14-3/4"	18-1/2"	18-3/4"															
	<p><b>ROLL-OUT HAMPER</b> •Canvas Bag</p> <p>Minimum Opening Required 15-1/4" Wide 19" High 18" Deep</p>	ROHB	280														
	<p><b>PLASTIC BIN ROLL-OUT HAMPER</b></p> <ul style="list-style-type: none"> <li>•60 quart Capacity</li> <li>•Easily Removable Hamper</li> </ul> <p>Minimum Opening Required 15-1/2" Wide 19-1/4" High 20" Deep</p>			RPHP	260												

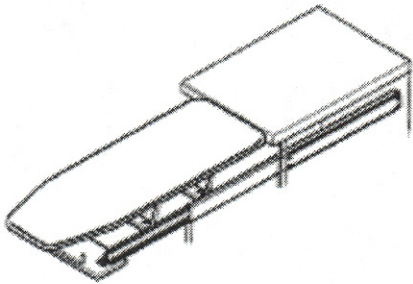
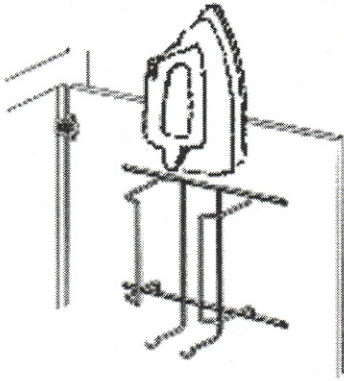
		<b>CODE</b>	<b>PRICE</b>
	<p><b>TOILET PAPER HOLDER</b></p>	<p>TPH</p>	<p>60</p>
	<p><b>BASIC™ WRAP RACK</b>                      •4 - 27 quart Bins                       8-1/2" X 11-3/4" X 3-1/2"</p>	<p>BWR</p>	<p>70</p>
	<p><b>STEP STOOL</b>                      •Mounts flat against the inside of cabinet door.                      •Folds out when needed.                      •Holds up to 200 pounds</p> <p>Dimensions                      A 10-1/4"                      B 13-1/2"                      C 15-7/8"                      D 3-3/8"                      E 7-3/4"</p>	<p>STOOL</p>	<p>320</p>
	<p><b>FOLDING STEP STOOL</b>                      •White                      •Can be stored under base cabinets                      •Kick board height</p>	<p>STOOLF</p>	<p>400</p>

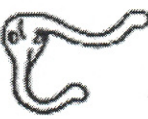
		<b>CODE</b>	<b>PRICE</b>
	<p><b>COSMETIC DRAWER INSERT</b>                      •Use in vanity drawers                       5" to 20-3/4" Wide                      16-3/8" to 17-3/4" Deep</p>	<p>CDI</p>	<p>175</p>
	<p><b>COSMETIC ORGANIZER PLUS</b>                      •Rolling Tray Kit</p>	<p>CDIP</p>	<p>250</p>
	<p><b>GROOMING RACK</b>                      •Holds Hair Dryer                      •2 Cans Hair Spray                      •2 Curling Irons                       9-1/4" Wide                      15-3/4" High                      5-3/8" Deep                      12" Minimum Opening</p>	<p>GR</p>	<p>130</p>
	<p><b>BASIC™ GROOMING RACK</b>                       9-1/4" Wide                      14-3/4" High                      5-1/2" Deep</p>	<p>BGR</p>	<p>130</p>

		<b>CODE</b>	<b>PRICE</b>
	<p><b>FOLD-OUT IRONING BOARD</b></p> <ul style="list-style-type: none"> <li>•Width is adjustable from 14-1/4" to 19-5/8"</li> <li>•Minimum height 4"</li> <li>•Depth 20"</li> </ul>	POIB	600
	<p>Extra Cover</p>		75
	<p><b>IRON HOLDER RACK</b></p> <ul style="list-style-type: none"> <li>8-1/2" High</li> <li>9" Wide</li> <li>5-1/2" Deep</li> </ul>	IHR	75
	<p><b>CEILING HOOK</b></p> <ul style="list-style-type: none"> <li>•2-1/4" Projection</li> </ul>	CH	15
	<p><b>COAT &amp; HAT HOOK</b></p> <ul style="list-style-type: none"> <li>•Brass Plated</li> <li>•3" Projection</li> <li>•1-1/4" Wide</li> <li>•1-3/4" High</li> </ul>	CHH	10
	<p><b>HANG ROD</b></p> <ul style="list-style-type: none"> <li>•3/8" to 1-1/4" Diameter</li> </ul>	HR	20
	<p><b>SPLIT ROUND CLOSET ROD COVER</b></p> <ul style="list-style-type: none"> <li>•White Plastic</li> <li>•Will fit wooden dowel or tubular steel closet rods.</li> </ul>	HR	20

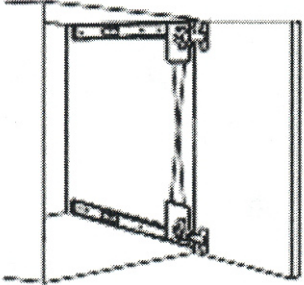
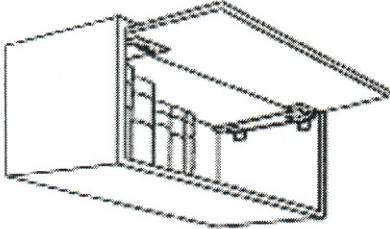
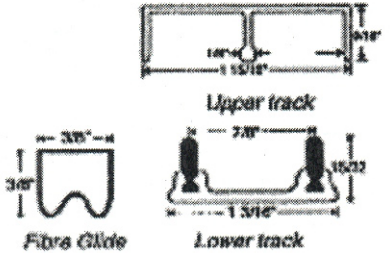
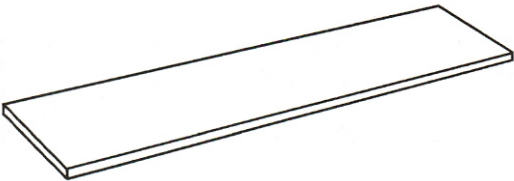
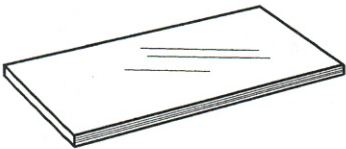
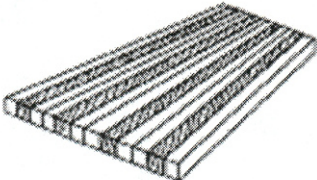
		<b>CODE</b>	<b>PRICE</b>
	<p><b>VERTICAL FLIPPER® DOOR SLIDES</b></p> <ul style="list-style-type: none"> <li>•Slide Cable System</li> <li>•75 lb. Capacity</li> </ul> <p>Factory recommended hinges per door                      Over 36" - 3 Hinges    Over 48" - 4 Hinges                      Over 60" - 5 Hinges    Over 72" - 6 Hinges</p>	PD	350 PER DOOR
	<p><b>OVER THE TOP FLIPPER® DOOR SLIDES</b></p> <ul style="list-style-type: none"> <li>•20 lb. Capacity</li> </ul> <p>8-1/2" High                      9" Wide                      5-1/2" Deep</p>	IHR	75
	<p><b>ALUMINUM SLIDING TRACK SETS</b></p> <ul style="list-style-type: none"> <li>•For 3/4" By-Passing Wood Doors</li> </ul>		Special Pricing
	<p><b>MELAMINE SHELVING</b></p> <ul style="list-style-type: none"> <li>•3/4" Thick</li> </ul>	MS	20 PER SQ. FT.
	<p><b>GLASS SHELVES</b></p> <ul style="list-style-type: none"> <li>•3/8" Thick</li> <li>•Polished one edge</li> </ul>	GS	60 PER SQ. FT.
	<p><b>SOLID MAPLE BUTCHER BLOCKS</b></p> <ul style="list-style-type: none"> <li>1-1/2" Solid</li> <li>3" Edge Trim</li> <li>6" Edge Trim</li> </ul> <p>Add 10% for Distressing                      Use "The Good Stuff" wear resistant finish                      for sealing cut blocks</p>	MGB	75 PER SQ. FT. 85 PER SQ. FT. 95 PER SQ. FT.

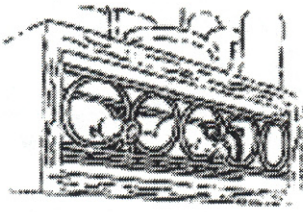
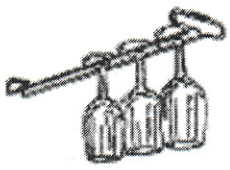
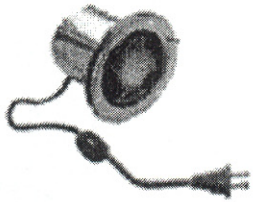
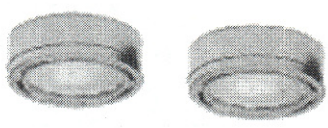
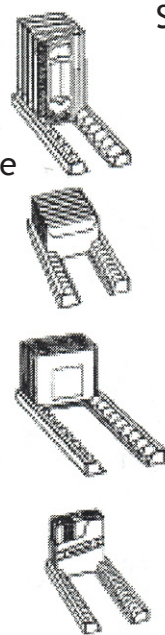
		<b>CODE</b>	<b>PRICE</b>
	<b>WINE STORAGE</b> •Brass plated steel, lacquered 3-9/16" ID x 4-1/2" OD	5 Ring Rack 23-11/16"	85
		6 Ring Rack 29-11/16"	90
	<b>METAL STEMWARE</b> •11" Long •16" Long	SWM	90 PER FT.
	<b>INCANDESCENT CANISTER LIGHTING</b> •Brass, Chrome, Black	ICL	90 PER FT.
	<b>LOW VOLTAGE/LOW PROFILE HALOGEN LIGHTING</b> •Includes 2 Lights and 1 Transformers •Brass, Chrome, Black, White	HHL	300
 <p>All Storage Rails are 12-1/2" Wide 1-9/16" High</p>	<b>STORAGE RAILS</b> VCR Tapes, capacity 10	VCRT	20
	Cassettes Tapes, capacity 16	CAT	20
	Compact Disc, capacity 24	CDT	20
	Nintendo®, capacity 16	NIT	20

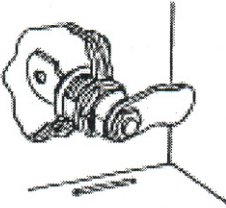
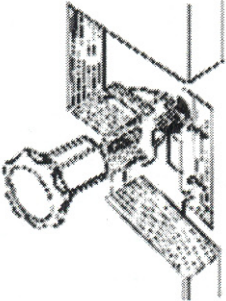
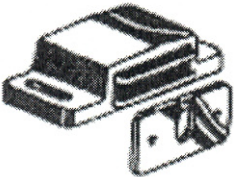
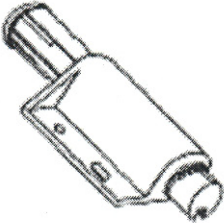
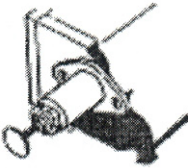
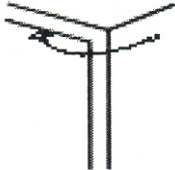
		<b>CODE</b>	<b>PRICE</b>
	<p><b>KEYED CAM LOCK</b></p> <ul style="list-style-type: none"> <li>•Available installed in any cabinet except on doors with finger pulls.</li> </ul>	KCL	50
	<p><b>REV-A-LOCK</b></p> <ul style="list-style-type: none"> <li>•Magnetic Key</li> </ul>	RAL	90
	<p><b>MAGNETIC CATCH</b></p>	MC	20
	<p><b>DOOR TOUCH LATCH</b></p>	TL	20
	<p><b>DRAWER TOUCH LATCH</b></p> <ul style="list-style-type: none"> <li>•Take off 3" of drawer depth</li> </ul>	DTL	50
	<p><b>DOOR STOP</b></p> <p>Prevents door face damage against counter top overhang next to tall unit doors. Various degrees may be obtained by relocating stop on door liner. Silent free acting vinyl-coated stainless steel aircraft-type cable.</p>	DOORSTOP	15





SWIVEL CASTER

RIGID CASTER



LIGHT-MEDIUM  
GENERAL DUTY CASTERS

**CODE**

**PRICE**



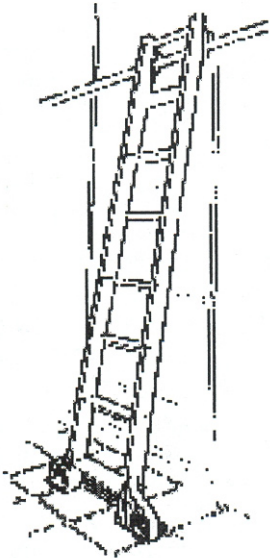

CASTER

50 EACH

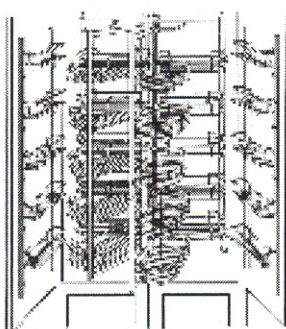
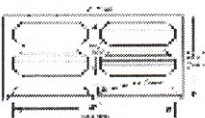

ROLLING TRACK LADDERS

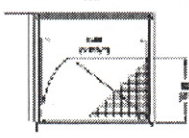
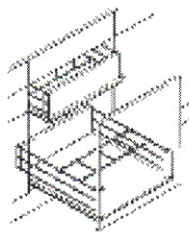
- Special Pricing
- See product spec sheets

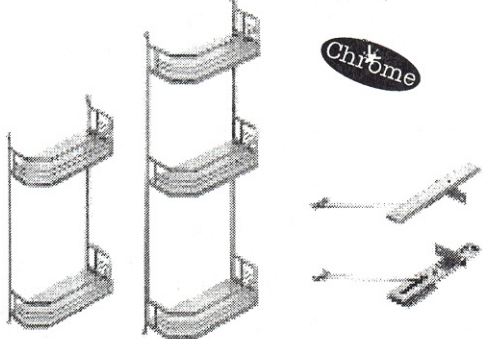
		CODE	PRICE
	<p><b>SWING PANTRY</b></p> <p>Full Set</p> <p><b>Chrome</b></p> <p>6022-21 CR                      60" x 18" x 24" (H x W x D)                      21" Deep (to cabinet)                      Chrome                      1/2" Thick                      Weight: 12.5 lbs</p> 	<p>SWINGPANTRY</p>	<p>5700</p>
	<p><b>SWING SHELF</b></p> <p>Set of 4 shelves 1 post</p> <p><b>Chrome</b></p> 	<p>SWINGSHELF</p>	<p>800</p>
	<p><b>DRAWER SLIDES</b></p> <p><b>Chrome</b></p> 	<p>DRCHROME</p>	<p>250 PER DRAWER</p>
 <p>8 1/4 W 3 1/2 D 14 1/4 H</p> <p>8 1/4 W 3 1/2 D 22 1/2 H</p>	<p><b>PULL OUT SHELVES</b></p> <p><b>Chrome</b></p>	<p>PULLOUT CHROME</p>	<p>500</p>

		<b>CODE</b>	<b>PRICE</b>
		<p><b>HAMPER CHROME</b></p>	<p>200</p>
<p><b>HAMPER</b> •For Cabinet Widths 11-3/4" and 17-3/4"</p>			
		<p><b>SINKCHROME</b></p>	<p>255</p>
<p><b>SINK STORAGE</b></p>			
		<p><b>MIRACLE</b></p>	<p>1400</p>
<p><b>MIRACLE CORNER</b> •Base Corner Unit System •Chrome Storage Basket</p>			
<p>• Available left or right hand mounting. The illustration here shows the right hand version. • Cabinet door mounts to frame.</p>			



INDEX		
	BALTIC BIRCH BIN PULL-OUT	17.13
	BALTIC BIRCH PULL-OUT	17.13
	BALTIC BIRCH SPICE RACK PULL-OUT	17.13
	BALTIC BIRCH TOWEL PULL-OUT	17.13
	BARN	9.6
	BASE 4	10.3
	BASE CABINET	2.3, 2.4, 2.10, 9.1, 17.8
	1 DRAWER	2.3
	2 DRAWERS	2.3, 2.4
	3 DRAWERS	2.4
	4 DRAWERS	2.4
	5 DRAWERS	2.4, 2.5
	6 DRAWERS	2.5
	ANGLE	2.12
	ANGLE 45	2.12
	ANGLE END SHELF	2.19
	BACK PANEL	9.3
	MATCH "A"	9.5
	MATCH "B"	9.7
	MATCH "C"	9.9
	BASE CORNER SINK 45	2.2
	BLIND CORNER CABINET	2.9
	DRAWER	2.9
	MIRACLE CORNER	17.23
	BOOKCASE	2.18
	CORNER 45	2.11
	CORNER 90	2.10
	DIVIDER	2.8
	DOUBLE ENTRY	2.13, 2.14
	DRAWER	2.6
	SUSPENDED	2.6
	CORNER	2.6
	DOUBLE	2.6
	END PANEL	9.2
	MATCH "A"	9.4
	MATCH "B"	9.6
	MATCH "C"	9.8
	FINISHED SIDE	9.1
	FRONTS	2.18
	HALF MOON LAZY SUSAN	2.9
	ISLAND RADIUS	2.17
	LAZY SUSAN 45	2.11
	LAZY SUSAN 90	2.10
	MICROWAVE	2.8
	OPEN SHELF	2.18
	ANGLED	2.19
	OVEN	2.8
	PAIRED DOORS	2.3
	PANTRY PULL-OUT	17.8
	PEDESTAL	2.6
	PILASTER	9.12. SEE ALSO PILASTER
	RADIUS END	2.17
	RADIUS OPEN SHELF	2.19
	RANGE	2.7
	2 DRAWERS	2.7
	PAIRED DOORS	2.7
	PEDESTAL	2.7
	ROLL-OUT TRAY	
	6"	2.20
	DOUBLE SLIDE	2.20
	OVERSIZED	2.20
	STANDARD	2.20
	SINGLE DOOR	2.3
	SINK	2.1, 2.2, 3.1, 3.2, 3.3, 17.23
	VENT	2.7
	WARMING DRAWER	2.8
	Z CABINET	2.12
	BASE FILLER	8.1
	BASE ORGANIZER	2.6
	BASE PEDESTAL	2.6
	BASE SINK	2.1
	BASE CORNER SINK	2.2
	BASE CORNER SINK 45	2.2
	PAIRED DOORS	2.2
	BASE FARM SINK	2.2
	BASE TRAY	2.8
	BASE VALANCE	11.2
	BASIC™ GROOMING RACK	17.16
	BASIC™ TWO-TIER DOOR	17.5
	BASIC™ WRAP RACK	17.15
	BASKET	17.8
	BASKETS	16.4
	HAMPER	17.23
	BASKET CABINET	16.4
	BEAD BOARD	9.4, 9.10. SEE ALSO WAINSCOTING
	BENCH	2.15
	DRAWER	2.16
	LIFT-UP TOP	16.12
	OPEN	2.16
	OPEN TOP	2.15
	RAISED PANEL FRONT	2.15
	SEAT	2.16
	WOOD DECK	2.16
	BIN PULL OUT	17.13
	BLACK BOARD	16.5
	BLIND CORNER	1.3, 1.4, 2.9, 3.5,

- 4.4, 5.8  
 BLOCKS 10.6  
 BLUM 7.1  
 BOOKCASE 1.10, 2.18  
 BOOTH SEATS 16.12  
 BRADFORD 9.4, 9.6  
 BREADBOARD 17.2  
 BREAD BOARD 17.2  
 BUILT-UP CROWN MOLD 10.7  
 BUILT-UP MOLDING 10.7  
 BUTCHER BLOCK 17.2  
 BUTCHER BLOCKS 17.18
- C**
- CAMBRIDGE CENTER 9.6  
 CANDY BIN 7.4  
 CANISTER LIGHTING 17.19  
 CANTERBURY 9.8  
 CASTERS 17.21  
 CATCH 17.20  
 CEILING HOOK 17.17  
 CFS 6 10.1  
 CFS 4 10.1  
 CHALK BOARD 16.5  
 CHICKEN WIRE D.2  
 CHINA DISPLAY RACK 16.2  
 CLOSET ROD COVER 17.17  
 CM41 10.1  
 CM551 10.1  
 COAT & HAT HOOK 17.17  
 COAT HOOKS 5.5  
 COAT RACK 16.6  
 CONTAINER PULL OUT 17.13  
 CORBEL 16.9  
 CORK BOARD 16.5  
 CORNER  
 DRAWER  
 SUSPENDED 2.6  
 CORNER FILLER 8.1  
 OVERLAY 8.1  
 CORNER MOLD 10.5  
 COSMETIC DRAWER INSERT 17.16  
 COSMETIC ORGANIZER PLUS 17.16  
 COTTAGE 9.8  
 COUNTER TRIM 10.5  
 COVE MOLD 10.3  
 CRISSCROSS WINE STORAGE 16.3  
 CROWN MOLD 10.1, 10.2, 10.3  
 BUILT-UP 10.7  
 DENTAL MOLD 10.4  
 SUB MOLD 10.4
- CROWN PEDIMENT. SEE PEDIMENT  
 CUP SHELF 16.2  
 CURVED BACK PANEL 9.10. SEE  
 ALSO BACK PANEL  
 CURVED DOOR D.8  
 CONCAVE D.8  
 CONVEX D.8  
 CURVED DRAWER FRONT D.8  
 CUSTOM ITEMS 1.13, 2.21, 3.12,  
 4.5, 5.12  
 CUSTOM PANELS 16.8  
 CUTLERY TRAY 17.1  
 CUT DOWNS P.1  
 CYLINDERS 12.4
- D**
- DECK TRIM 10.5  
 DENTAL MOLD 10.4  
 DESK BASE 4.1  
 BLIND CORNER 4.4  
 DIVIDER 4.4  
 DRAWER 4.3  
 DRAWER KNEE SUPPORT 9.11  
 END PANEL 9.11  
 FILE 4.2  
 FILE LATERAL 4.2  
 LEG PANEL 9.11  
 LETTER SLOTS 16.4  
 OPEN SHELF 4.4  
 PAIRED DOORS 4.1  
 PENCIL DRAWER 4.3  
 PHONE BOOK CADDY 16.4  
 PULL OUT 4.2  
 DESK DRAWER KNEE SUPPORT 9.11  
 DISH WASHER 13.1  
 DISTRESSING F.1  
 DIVIDER 1.12, 2.8, 3.8, 4.4, 5.2,  
 5.4, 5.8, 7.4, 17.9  
 DIVIDER WALL 1.12  
 DOORS  
 ANGLED TOP D.7  
 ARCHED D.7  
 CHICKEN WIRE D.2  
 CURVED D.8  
 GLASS D.1  
 GRILL WIRE D.2  
 MULLION D.2, D.3  
 MULTIPLE FRONTS D.10  
 OVER THE TOP FLIPPER® SLIDES  
 D.10  
 PAINTED PANELS D.9
- SAMPLE D.1  
 SPEAKER CLOTH D.1  
 SQUARE PEGS D.10  
 TALL D.9  
 VERTICLE FLIPPER® SLIDES D.10  
 WOOD MESH D.2  
 Z D.10  
 DOOR CATCH D.9  
 DOOR LADDER 17.5  
 DOOR SLIDES 17.18  
 DOOR STOP 17.20  
 DOOR STORAGE TRAYS 17.6  
 DOOR TOUCH LATCH 17.20  
 DOUBLE-TIERED CUTLERY TRAY  
 17.1  
 DOUBLE BIN SLIDE-OUT 17.10  
 DOUBLE ENTRY BASE 2.13, 2.14  
 DOUBLE OVEN 5.6, 5.7, 6.1  
 DOVETAIL 7.1  
 DOWEL 16.5  
 DOWNS 9.4  
 DRAWER D.9, 1.3, 2.3, 2.5, 2.6,  
 2.8, 2.9, 2.13, 2.14, 2.16,  
 2.20, 3.2, 3.4, 3.5, 3.8,  
 3.11, 4.1, 4.2, 4.3, 5.2, 5.5,  
 7.1, 7.2  
 CANDY BIN 7.4  
 COSMETIC INSERT 17.16  
 CURVED DRAWER FRONT D.8  
 DOVETAIL 7.1  
 FILE 7.3  
 GRAIN BIN 7.4  
 LATERAL FILE 7.3  
 LINEN 7.3  
 METAL LINER 7.4  
 MULTIPLE FRONTS D.10  
 PENCIL DRAWER 4.3  
 PIGEONHOLE 16.4  
 RIBBON 7.3, 16.5  
 SLIDES 17.22  
 UPGRADE 7.1  
 WDR DRAWER 16.4  
 DRAWER DIVIDER 7.4  
 DRAWER SLIDES 17.22  
 DRAWER TOUCH LATCH 17.20
- E**
- E17 6.3  
 END PANEL 9.2, 9.4, 9.6, 9.8, 9.11  
 DESK 9.11  
 MELAMINE 9.11

- ENKEBOLL. SEE ATTACHED PRICE LIST;  
SEE ALSO MOLD, MOLDING
- ENTERTAINMENT CENTER 5.7  
VCR SHELF 16.2
- ESSEX 9.4, 9.6
- F**
- FACE FRAME 6.2  
ANGLED 6.3  
DOUBLE OVEN 6.1  
FOR DOORS 6.3  
FOR INSET DOORS 6.3  
MICROWAVE 6.1  
OVEN 6.1  
SINGLE OVEN 6.1  
VALANCE 6.2
- FACIA 15.1  
FACIA MOLD 10.4  
FACIA 302 MOLDING 10.7
- FACTORY SUPPLIED TOE BOX 11.3
- FILES 17.3
- FILE DRAWER 7.3
- FILE HOLDER PULL-OUT 17.3
- FILLER 8.1, 8.2, 9.15  
6" 8.2  
CORNER 8.1  
OVERLAY 8.1  
OVERLAY 8.1
- FINISHED SIDE 9.1
- FINISHES F.1
- FLAT FC3 10.3
- FLIPPER® D.10, 17.18
- FLOOR 16.8
- FOLD-OUT IRONING BOARD 17.17
- FOLDING STEP STOOL 17.15
- FOOT 12.3, 12.4
- FORMS M.1
- FRIDGE 13.1
- FRONTS D.10, 1.3, 2.6, 2.18
- G**
- GENERAL DUTY CASTERS 17.21
- GLASS DOOR D.1  
1/4" GLASS DOOR D.1  
TEMPERED GLASS D.1
- GLASS SHELVES 17.18
- GLAZING F.1
- GLIDES 1.3, 2.3, 2.4, 2.5, 2.7,  
2.8, 3.7, 4.2, 4.3, 17.2
- GLIDES, HEAVY DUTY FULL-EXTENSION 2.5
- GRAIN BIN 7.4
- GRILL WIRE D.2
- GROMMETS 17.4
- GROOMING RACK 17.16
- H**
- HAFELE BASKETS. SEE BASKETS
- HALF RADIUS 16.11
- HALF TURNED PILASTER 9.13
- HALOGEN LIGHTING 17.19
- HAMPER 17.14, 17.23
- HAT HOOK 17.17
- HEAVY DUTY FULL-EXTENSION GLIDES 2.4,  
2.5
- HOOD 14.1, 14.2
- HUTCH  
END PANEL 9.11  
SCROLLED END PANEL 9.11
- I**
- INCANDESCENT CANISTER LIGHT-  
ING 17.19
- IRONING BOARD 17.17
- IRONING BOARD DOOR 16.2
- IRON HOLDER RACK 17.17
- ISLAND 2.17
- J**
- JOHN CABINET 3.9
- K**
- KEYBOARD TRAY 17.4
- KEYED CAM LOCK 17.20
- KNIFE BLOCK 17.2
- KNIFE DRAWER 17.2
- KNOTTINGHAM 9.8
- L**
- LADDER 17.5, 17.21
- LATCH, DOOR 17.20
- LATCH, DRAWER 17.20
- LATERAL FILES 17.3
- LATERAL FILE DRAWER 7.3
- LATTICE WINE STORAGE 16.3
- LAZY SUSAN 1.5, 1.6, 2.9, 2.10,  
2.11, 17.6, 17.7  
FULL ROUND 17.6  
HALF MOON 17.6  
KIDNEY 17.6  
REVOLVING "D" 17.7  
SINGLE TRAY 17.7  
SUPER SUSAN 17.7
- THREE TRAY SET 17.7
- LEGS 12.1, 12.2, 12.3, 12.4
- CYLINDERS 12.4  
FOOT 12.3  
PILASTER LEG 12.3
- LEG PANEL 9.11
- LETTER SLOTS 16.4
- LIFT-UP TOP 16.12
- LIGHTING 17.19
- LIGHT RAIL 10.5  
LIGHT RAIL MOLDING 10.5  
RADIUS 10.8
- LINEN DRAWER 7.3
- LOCK 17.20
- LOCKERS 5.5
- LOW VOLTAGE, PROFILE LIGHTING  
17.19
- M**
- MAGNETIC CATCH 17.20
- MANHATTAN 9.4
- MANTEL 15.1  
CARRIAGE HOUSE 15.2  
MANTEL FINISHING 15.1
- MATCH "A" 9.4
- MEDICINE CABINET 3.9  
FRAMED DOOR 3.9  
PLAIN DOOR 3.9  
TRI-MIRROR 3.10
- MELAMINE ADJUSTABLE SHELF 5.5
- MELAMINE SHELVING 17.18
- METAL LINER 7.4
- METAL STEMWARE 17.19
- MICROWAVE  
BASE 2.8  
MICROWAVE FACE FRAME ONLY 1.8  
MICROWAVE FRAME 6.1  
MICROWAVE WALL CABINET 1.8  
MICROWAVE WOOD INTERIOR 1.8
- MIRACLE CORNER 17.23
- MIRROR 3.10  
MIRROR FRAME 3.10, 6.4
- MITER 9.13, 10.1, 10.2, 10.3, 10.4,  
10.5, 10.6, 10.7, 10.8,  
16.10, , 16.12
- MIXED COLORS 1.13, 2.21, 3.12,  
4.5, 5.12
- MOLD, MOLDING 10.1, 10.2, 10.3,  
10.4, 10.5, 10.6, 10.7, 10.8,  
16.10  
ENKEBOLL 10.8

- FINISHING 10.8  
 SET-UP FEES 10.8  
 MULLION DOOR D.2, D.3, D.4,  
 D.5, D.6  
 ARCHED MULLION DOOR D.6  
 MULTIPLE FRONTS D.10, 1.3, 2.6
- N**  
 NARROW ROLL-OUT BASE UNIT 17.8  
 NEW CASTLE 9.8  
 NEW YORKER 9.6  
 NOTCH 5.9
- O**  
 OVEN 2.8, 6.1  
 OVEN FRAME 6.1  
 OVERHEAD CABINET DECKING 16.8  
 OVERLAY FILLER 8.1  
 OVER THE TOP FLIPPER® DOOR  
 SLIDES D.10  
 OXFORD 9.4
- P**  
 PAINTED PANELS D.9  
 PANTRY SHELF 16.10  
 PANTRY SYSTEM 17.8  
 PAPER MANAGER 17.4  
 PEDESTAL 2.6, 2.7, 3.8  
 PEDIMENT 10.7  
 ARCHED 10.7  
 CROWN 10.7  
 PENCIL DRAWER 4.3  
 ANGLED 4.3  
 DOUBLE 4.3  
 SUSPENDED 4.3  
 PHONE BOOK CADDY 16.4  
 PIGEONHOLE DRAWERS 16.4  
 PILASTER 9.12, 9.13, 9.14, 9.15  
 1/2 9.15  
 1/2 LEG 12.3  
 1/2 TURNED 9.13  
 BOX 9.13  
 BOX NOT REQUIRED 9.14  
 BOX REQUIRED 9.12  
 HALF TURNED 9.13  
 RADIUS CORNER 9.13  
 RIBBED 9.13, 9.15  
 PIVOT-OUT WASTE CONTAINER  
 17.11  
 PLASTIC BIN ROLL-OUT HAMPER  
 17.14
- PLATFORM 16.8  
 PONY WALL 16.11  
 PONY WALL RADIUS 16.11  
 PROCEDURES P.1  
 PULL OUT 17.13  
 PULL OUT PANTRY SYSTEM 17.8  
 PULL OUT SHELVES 17.2, 17.22  
 PULL OUT TABLE 17.3  
 PULL OUT TRAY DIVIDER 17.9
- Q**  
 QUARTER MOLD 10.6  
 QUARTER RADIUS 16.11  
 QUEEN ANNE 12.3
- R**  
 RADIUS 1.7, 1.11, 2.17, 2.19,  
 9.13, 10.8, 16.11  
 HALF RADIUS 16.11  
 OPEN SHELF 2.19  
 QUARTER 16.11  
 RADIUS CORNER 9.13  
 RADIUS LIGHT RAIL 10.8  
 RADIUS SUB MOLD 10.8  
 RAIL. SEE FACE FRAMES  
 RAIL 6.2  
 RAILS 17.19  
 RANGE 2.7  
 BASE RANGE PEDESTAL 2.7  
 RAYMOND ENKEBOLL 10.8. SEE  
 ALSO MOLD, MOLDING  
 RECYCLING CENTER 17.11, 17.12  
 REFRIGERATOR 13.1  
 REFRIGERATOR WALL CABINET 1.8  
 RENAISSANCE 9.8  
 REV-A-LOCK 17.20  
 REVOLVING "D" SHELF PANTRY  
 SYSTEM 17.7  
 RIBBON DRAWER 7.3, 16.5  
 RIGID CASTER 17.21  
 ROLL-OUT TRAY 2.20, 5.5, 7.2,  
 17.9  
 6" 7.2  
 DOUBLE SLIDE 2.20, 7.2  
 OVERSIZED 7.2  
 ROLLING TRACK LADDERS 17.21  
 ROPE MOLD 10.6  
 TERMINATION BLOCK 10.6  
 ROTARY RECYCLING CENTER 17.11  
 ROUNDED 1.9  
 ROUND PLASTIC GROMMETS 17.4
- ROUND WINE STORAGE 16.3
- S**  
 SAMPLE DOOR D.1  
 SANTA FE 9.4, 9.6  
 SCRIBE MOLD 10.5, 10.6  
 SHAKER 9.4  
 SHAKER BEAD 9.6  
 SHAKER CLASSIC 9.6  
 SHELF, SHELVES 5.5, 16.10  
 GLASS SHELVES 17.18  
 MELAMINE SHELVING 17.18  
 PANTRY 16.10  
 PULL OUT SHELVES 17.22  
 WIRE ROLL-OUT 17.8  
 SHERWOOD 9.4, 9.6  
 SHERWOOD BEAD 9.8  
 SINGLE-BIN SLIDE-OUT 17.10  
 SINGLE LIFT UP DOOR 1.1  
 SINGLE OVEN 5.6  
 SINGLE OVEN DRAWER 5.6  
 SINGLE TRAY LAZY SUSAN 17.7  
 SINK STORAGE 17.23  
 SKI RACK 16.6  
 SLIDE-OUT 17.10  
 SLIDES D.10  
 SOFFIT PANEL 16.8  
 SPEAKER CLOTH D.1  
 SPICE DRAWER INSERT 17.1  
 SPICE PULL-OUT 14.3  
 SPICE RACKS 16.2, 17.5  
 ADJUSTABLE 17.1  
 SPICE RACK PULL OUT 17.13  
 SQUARE PEGS D.10  
 ST. VINCENT 9.6  
 STAIR SHELF 17.1  
 STANFORD 9.8  
 STEMWARE RACK 16.3  
 STEP STOOL 17.15  
 STOOL 17.15  
 STORAGE RAILS 17.19  
 STOVE TOP 2.7  
 STRAIGHT WOOD DECK 16.10  
 SUB MOLD 10.4  
 RADIUS 10.8  
 SUB ZERO. SEE APPLIANCE PANEL  
 SUPER SUSAN 17.7  
 SWING OUT PANTRY 17.5  
 SWING PANTRY 17.22  
 SWING SHELF 17.22  
 SWIVEL CASTER 17.21



- T**
- TABLEWARE TRAY INSERTS 17.1
- TABLE APRON 16.1
- TABLE SLIDES 17.3
- TALL**
- BACK PANEL 9.3
- MATCH "A" 9.5
- MATCH "B" 9.7
- MATCH "C" 9.9
- BLIND CORNER 5.8
- DIVIDER 5.8
- DIVIDER 5.4
- DOUBLE OVEN 5.6, 5.7
- DRAWER 5.2
- END PANEL 9.2
- MATCH "A" 9.4
- MATCH "B" 9.6
- MATCH "C" 9.8
- ENTERTAINMENT CENTER 5.7
- FACE FRAME 5.9
- FINISHED SIDE 9.1
- LOCKERS 5.5
- NOTCH 5.9
- PILASTER. SEE PILASTER
- SINGLE OVEN 5.6
- UTILITY 5.5, 5.7
- TALL DOORS D.9
- TALL FILLER 8.1
- TALL PANTRY 5.1, 5.2
- 2 DOORS 5.1
- TYPE "A" 5.3
- 4 DOORS 5.2
- TYPE "A" 5.4
- FRAMED 5.9
- TALL SECTION 5.11
- TALL UTILITY 5.5, 5.7
- TEMPERED GLASS D.1
- TERMINATION BLOCK 10.6
- TILT-OUT HAMPER 17.14
- TIP-OUT UTILITY TRAYS 17.1
- TOE BOX 11.3
- TOE KICK
- CORNER 11.3
- COVER 11.3
- RADIUS 11.3
- TOE KICKS 11.1, 11.2, 11.3
- FLUSH 11.1
- TOE KICK COVER 11.3
- TOILET PAPER HOLDER 17.15
- TOP BURNER 2.7
- TOP COAT F.1
- TOP RAILS 6.2
- TOWEL BAR 17.9
- TOWEL PULL OUT 17.13
- TRACK SETS 17.18
- TRASH CAN 17.10
- TRASH COMPACTOR 13.1
- TRASH HOLDER 17.10
- TRAY 2.8, 17.9
- TRAY DIVIDERS 17.9
- TRUE RAISED 9.4
- TV PLATFORM 2.15
- TV PULL-OUT 17.4
- TV SWIVEL 17.4
- TWO-TIER DOOR 17.5
- U**
- UPPER**
- ARCHED CABINET 1.10
- BACK PANEL 9.3
- MATCH "A" 9.5
- MATCH "B" 9.7
- MATCH "C" 9.9
- BOOKCASE 1.10
- DIVIDER WALL 1.12
- END PANEL 9.2
- MATCH "A" 9.4
- MATCH "B" 9.6
- MATCH "C" 9.8
- FINISHED SIDE 9.1
- LAZY SUSAN 1.5
- OPEN BOTTOM BOOKCASE 1.10
- PAIRED DOOR 1.2
- PILASTER 9.12. SEE ALSO PILASTER
- SINGLE DOOR 1.1
- SINGLE LIFT UP DOOR 1.1
- VENT COVER 1.12
- WALL ANGLE 1.9
- WALL ANGLE 45 1.7
- WALL BLIND CORNER 1.3
- WALL CORNER 45 1.5
- LAZY SUSAN 1.5
- WALL CORNER 90 1.6
- LAZY SUSAN 1.6
- WALL CORNER OPEN 45 1.11
- WALL CORNER OPEN 90 1.11
- WALL CORNER OPEN RADIUS 1.11
- WALL CORNER RADIUS END 1.7
- WALL DOUBLE ENTRY 1.4
- BLIND CORNER 1.4
- WALL DRAWER 1.3
- WALL END ROUNDED 1.9
- WALL MICROWAVE 1.8
- MICROWAVE WOOD INTERIOR 1.8
- WALL OPEN SHELVES 1.10
- WALL REFRIGERATOR 1.8
- WALL ROUNDED 1.9
- V**
- VALANCE 6.2, 16.7. SEE ALSO FACE FRAME
- CUSTOM 16.7
- VANITY 2.23, 3.1, 3.2, 3.3, 3.4, 3.5, 3.6, 3.7, 3.8, 3.9, 3.10, 3.11, 3.12
- ANGLE DRAWER SUSPENDED 3.8
- BASE 3.4
- 1 DRAWER 3.4
- 2 DRAWERS 3.4
- BLIND CORNER 3.5
- DRAWER 3.5
- CORNER 45 3.6
- PAIRED DOORS 3.6
- DIVIDER 3.8
- DRAWER 3.7
- ANGLE DRAWER SUSPENDED 3.8
- SUSPENDED 3.8
- FILE 3.7
- PAIRED DOORS 3.4
- PEDESTAL 3.8
- PULL OUT 3.7
- SINGLE DOOR 3.4
- HUNG VANITIES 3.3
- JOHN CABINET 3.9
- LINEN 3.11
- MEDICINE CABINET 3.9
- TALL 3.3
- VANITY SINK 3.1, 3.2
- APRON 3.2
- CORNER SINK 45 3.3
- DRAWER 3.2
- PAIRED DOORS 3.1
- VCR SHELF 16.2
- VENEER PANEL 9.2, 9.3
- VENT COVER 1.12
- VERTICAL FLIPPER® DOOR SLIDES 17.18
- VERTICLE FLIPPER® DOOR SLIDES D.10
- VICTORIAN 9.8

## W

"Z" DOOR D.10

Z CABINET 2.12

WAINSCOTING 9.10  
 WALL ANGLE 1.9  
 WALL ANGLE 45 1.7  
 WALL BLIND CORNER 1.3  
 WALL CABINET. SEE UPPER  
 WALL CORNER 45 1.5  
 WALL CORNER 90 1.6  
 WALL CORNER OPEN 45 1.11  
 WALL CORNER OPEN 90 1.11  
 WALL CORNER OPEN RADIUS 1.11  
 WALL CORNER RADIUS END 1.7  
 WALL DOUBLE ENTRY 1.4  
 WALL DRAWER 1.3  
 WALL FILLER 8.1  
 WALL OPEN SHELVES 1.10  
 WALL RACK 17.5  
 WALL ROUNDED 1.9  
 WALL SPICE RACKS 16.2  
 WARMING DRAWER 2.8  
 WASTE BASKETS 17.10  
 WASTE CONTAINERS 17.10, 17.11  
 WASTE MANAGEMENT SYSTEM  
     17.11  
 WATERFORD 9.4  
 WDR DRAWER 16.4  
 WHITE BOARD 16.5  
 WINDSOR 9.4, 9.6  
 WINE RACK CRADLE 16.3  
 WINE STORAGE 16.3, 17.19  
     CRISSCROSS 16.3  
     LATTICE 16.3  
     ROUND 16.3  
     STEMWARE RACK 16.3  
     WINE RACK CRADLE 16.3  
 WIRE ROLL-OUT SHELVES 17.8  
 WIRE SPICE RACKS 17.5  
 WOOD DECK 2.16, 16.10  
     ANGLE 16.10  
 WOOD MESH D.2  
 WOOD SHELVES 16.10  
 WOOD SPICE RACK 17.5  
 WRAPPING CENTER 16.5  
     WRAPPING CENTER DOWELS 16.5  
 WRAPPING PAPER 16.5  
 WRAP RACK 17.15

## Y

YORKSHIRE 9.4, 9.6

## Z